



e-tron GT

The Audi e-tron GT.

The Audi e-tron GT quattro is a modern-day demonstration of progress. It radiates sportiness, exclusivity and comfort. Its aerodynamic design and gran turismo concept are an irresistible eye-catcher. Driving it is a thoroughly emotional experience.

This pricelist will make it easy for you to build your e-tron GT, taking you through all the model and option choices. The online configurator is also available to build your dream car.



Note: vehicle depicted may contain equipment not currently available for the South African market.



Models

Models	Battery (kW)	Power output (kW)	Torque (Nm)	Electric Consumption combined (WLTP) (kWh/100 km)	CO ₂ emissions (g/km)	Electric range** Combined (WLTP) (km)	0 – 100 km/h (sec)	Top speed (km/h)	RRP*
GT quattro	93	350	630	19.6 - 18.8 (NEDC)	0	452- 488	4.5	245	R2,715,000

Fuel consumption and CO₂ data applies to the German Market. The specified values are determined in accordance with certain test procedures. The specifications do not refer to an individual vehicle but serve only as a basis for comparing the different types of vehicles. In addition, the consumption figures achieved during normal driving may differ from the test values, depending in particular on special equipment fitted, vehicle loading, personal driving style, road and traffic conditions, environmental factors and conditions of the car.

* RRP is inclusive of VAT, CO₂ emissions tax and a 5 year/100,000km Audi Freeway Plan

** Figures depend on the equipment selected



Standard Equipment: e-tron GT

Wheels

- ▶ Anti-theft wheel bolts
- ▶ Space-saving spare wheel
- ▶ Tyre pressure monitoring system
- ▶ Steel brakes in front and rear with black brake calipers
- ▶ Tyres 245/45 R20 103Y in front tyres 285/40 R20 108Y in rear
- ▶ Wheels, 5-double-spoke offset style, Platinum grey, 9.0J|11.0J x 20, 245/45|285/40 R20 tyres

Interior equipment

- ▶ 3-point seat belts in front, with manual height adjustment
- ▶ 3-zone climate control system
- ▶ Contour ambient lighting package (multi-colour)
- ▶ Anti-theft alarm system
- ▶ Auto-dimming interior rearview mirror, frameless
- ▶ Decorative inserts in graphite grey fine paint
- ▶ Driver and front passenger airbag with front passenger airbag deactivation
- ▶ Electric steering wheel adjustment
- ▶ First aid kit with warning triangle and safety vests
- ▶ Headliner in Black fabric
- ▶ ISOFIX child seat anchors and i-Size for outer rear seats with top tether for all rear seats
- ▶ Power front seats with memory feature for the driver
- ▶ Seat heaters in front
- ▶ Stationary air conditioning
- ▶ Sun visor on driver and front passenger side
- ▶ Three rear seats
- ▶ Upper and lower interior elements in leatherette
- ▶ Leather/leatherette combination upholstery

- ▶ Sports contour leather-wrapped multi-function plus steering wheel, 3-spoke, flat-bottomed with shift paddles
- ▶ Sports seats in front

Safety & Convenience

- ▶ 360-degree cameras
- ▶ Comfort key with sensor-controlled luggage compartment release
- ▶ Lane departure warning
- ▶ Parking aid plus with 360° display
- ▶ Service indicator 30 000 km or 2 years (fix) electric vehicle
- ▶ Side airbags in front and rear and curtain airbag system

Performance & suspension

- ▶ Cruise control system with speed limiter
- ▶ e-tron sports sound
- ▶ quattro with open rear differential
- ▶ Adaptive air suspension

Audio & Communication

- ▶ Audi connect Emergency Call & Service
- ▶ Audi connect Navigation & Infotainment
- ▶ Audi phone box
- ▶ Audi smartphone interface
- ▶ Bang & Olufsen premium sound system with 3D sound
- ▶ MMI Navigation plus with MMI touch



Standard Equipment: e-tron GT

Lighting

- ▶ Matrix LED headlamps with dynamic turn signal
- ▶ LED rear combination lamps with dynamic turn signal











Exterior equipment

- ▶ Black decorative trims
- ▶ Exterior mirror housings in body colour
- ▶ Exterior mirrors, power-adjustable, heated and power-folding, auto-dimming on both sides, with memory feature
- ▶ Panoramic glass sunroof
- ▶ Rear window, rear door windows and side windows in clear glass
- ▶ Scuff plates with aluminum inserts in front and rear
- ▶ Side and rear windows with heat-reflecting glass
- ▶ Singleframe in Hekla grey
- ▶ Windshield with heat-insulating glass and acoustic glass







Electric specifications

- ▶ 400-Volt boost converter
- ▶ e-tron charging system "compact"
- ▶ High-voltage battery 93 kWh (gross)
- ▶ Household plug Type M (South Africa) for the e-tron charging system
- ▶ Industrial plug CEE 32 A, 230 V, long and straight, for the e-tron charging system
- ▶ On-board charger 11kW (AC)
- ▶ Mode 3 charging cable for public charging 22 kW (AC)
- ▶ Second charging access
- ▶ Vehicle charging cable
- ▶ Vehicle inlet CCS type 2
- ▶ Wall bracket



Paint			e-tron GT
9W9W		Ascar Blue Metallic	No cost
L5L5		Floret Silver Metallic	No cost
8R8R		Kemora Grey Metallic	No cost
0E0E		Myth Black Metallic	No cost
M1M1		Suzuka Grey Metallic	No cost
V0V0		Tactics Green Metallic	No cost
Y1Y1		Tango Red Metallic	No cost
6Y6Y		Daytona Gray Pearlescent	No cost
T9T9		Ibis White	No cost
Q0Q0		Individual paint finish, Audi exclusive	R88,000



Wheels & Tyres			e-tron GT
47K		Wheels, 5-double-spoke offset style, Platinum grey, 9.0J 11.0J x 20, 245/45 285/40 R20 tyres	Std
47H		Wheels, 5-double-spoke offset style, Black, diamond-turned, 9.0J 11.0J x 20, 245/45 285/40 R20 tyres	R6,000
47I		Wheels, 5-spoke aerodynamic module style, Black, diamond-turned, 9.0J 11.0J x 20, 245/45 285/40 R20 tyres	R15,100
47L		Wheels, 10-spoke trapezoidal module style, Platinum grey, diamond-turned, 9.5J 11.5J x 21, 265/35 305/30 R21 tyres	R35,100
47J		Wheels, 10-spoke trapezoidal module style, Black, diamond-turned, 9.5J 11.5J x 21, 265/35 305/30 R21 tyres	R35,100
54C		Wheels, 10-spoke trapezoidal module style, Matte Titan. grey, diamond-turned, 9.5J 11.5J x 21, 265/35 305/30 R21 tyres	R35,100
44I		Wheels, 5-double-spoke concave module style with graphic print, Black, 9.5J 11.5J x 21, 265/35 305/30 R21 tyres	R50,100



Optional equipment		e-tron GT
Styling packages		
5L3	Appearance package in Glossy Carbon Side air ducts, front, inlays in the door trim strips and horizontal bar in the rear diffuser in gloss carbon. Only in conjunction with black styling package (4ZD) or black styling package plus (4ZP).	R86,400
4ZP	Black Appearance package Plus The black styling package plus includes: · Singleframe mask, lower section of the front and rear bumpers, side sills with inlay in the door trim strips and diffuser in gloss black · Audi rings and logos in gloss black Forces Singleframe in body colour or black	R32,000
4ZD	Black Styling package The black styling package includes: · Singleframe mask, lower section of the front and rear bumpers, side sills with inlay in the door trim strips and diffuser in gloss black · Audi rings and logos in chrome	R26,100
6H1	Singleframe in body color	R7,100
6H2	Singleframe in Glossy Black (forces 4ZD or 4ZP)	No Cost
Lighting and Mirrors		
PXC	Matrix LED headlamps with Audi laser light and LED rear combination lamps, lighting scheme and dynamic turn signal Highly adaptive light distribution, precise illumination with significantly reduced dazzle for oncoming traffic and vehicles ahead, combined with unmistakable design and innovative, futuristic looking specific light sequencing. Including laser light with extensive reach and LED rear lights.	R57,800
6FJ	Black exterior mirror housings	R2,100
6FQ	Carbon exterior mirror housings	R15,900



Optional equipment		e-tron GT
Interior equipment		
6NC	Headliner in Black Dinamica® microfiber	R41,200
1N8	Electromechanical power steering Plus The optimised progressive steering increases driving dynamics and driving comfort thanks to speed-dependent power assistance for a more precise steering feel at higher speeds and outstanding assistance when parking and manoeuvring due to reduced steering effort.	R4,800
2PF	Sports cont. leather-wr. multi-funct. Plus steering wheel in Alcantara®, w/ shift paddles, 3-spoke, flat-bottomed (forces PEF/PEG/PEH)	No cost
1XP	Sports contour leather-wrapped MF Plus steering wheel, 3-spoke, heated, shift paddles, flat-bottomed	R3,800
2V4	Air quality package Ionisation reduces harmful particles and germs in the air, thus improving the air quality in the vehicle interior. The air quality package can help improve comfort and attention levels.	R4,800
GA2	Comfort stationary air conditioning In addition to the standard stationery air conditioning, further equipment such as seat heating and window heating can be activated with comfort stationary air conditioning	R1,700
9M3	Heat pump The heat pump uses waste heat from the drivetrain to efficiently warm the vehicle interior. When the outside temperature drops below 20°C and the climate control is active, the heat pump can help save energy. This can have a positive effect on range.	R10,100
VT3	Glossy Carbon scuff plates in front and rear, illuminated	R20,100
7M9	Scuff plates with aluminum inserts in front and rear, illuminated	R10,100
VW0	Acoustic glass for door and side windows	R13,900
4GY	Climate-controlled windshield / acoustic glass The additional reflective coating reduces the build-up of heat in the interior in intense sunlight and can thus help to enhance the occupants' comfort and reduce the power consumption of the air conditioning. With viewing window for toll collection devices; double glazing provides exterior noise insulation.	R9,100
4GK	Windshield with heat-insulating glass and acoustic glass with Gray tinted sunshield	R2,100



Optional equipment		e-tron GT
Seats Upholstery Inlays		
4A4	Seat heaters in front and rear	R8,100
4D5	<p>Seat ventilation and massage feature in front</p> <p>The active seat ventilation for the seat and backrest centre panels for the driver and front passenger seat provides a pleasant seat climate even at high outside temperatures by drawing in air. For ventilation, air is sucked in through the perforated leather on the seat centre panel and backrest centre panel of the driver and front passenger seat; the intensity can be adjusted in three stages via the air-conditioning controls. Seat heating is activated automatically to prevent cold seats. The leather on the ventilated front seats and the non-ventilated outer rear seats is perforated. The massage function includes eight different massage programs that were developed specifically for relaxing your back and shoulder muscles. Each front seat has a total of ten pneumatic cushions. These can be adjusted in three levels of intensity. The programs and intensity are adjusted on the MMI touch display.</p>	R15,100
4D3	Seat ventilation in front (forces N0Q & Q1J)	No cost
Q2J	<p>Sports seats Plus in front</p> <p>Sports seats plus front include:</p> <ul style="list-style-type: none"> • integrated headrests • pronounced side cheeks • electrical adjustment of seat height, fore / aft position, seat and backrest inclination and seat depth adjustment • pneumatic lumbar support • manual adjustment of belt height • heated seats in the front • optionally available: heated seats front and rear • optionally selectable: memory function for the driver's seat • pronounced outer rear seats and an additional central seating option with manually heightadjustable headrests • Rear seat backrest divisible in a ratio of 40:20:40 or completely foldable • Center armrest at the rear, one-piece and foldable, with cup holder <p>Forces Dinamica (N7U) or Cascade (N2Y) fabric at no cost</p>	R39,900
Q1J	<p>Sports seats Pro in front</p> <p>Sports seats pro front include:</p> <ul style="list-style-type: none"> • integrated headrests • significantly more pronounced side cheeks • electrical adjustment of seat height, fore / aft position, seat and backrest inclination and seat depth adjustment • pneumatic adjustment of the seat and backrest bolsters as well as pneumatic lumbar support • manual adjustment of the belt height • Seat heating and ventilation at the front • Optionally selectable: massage function for driver and front passenger as well as heated seats front and rear • optionally selectable: memory function for the driver's seat • pronounced outer rear seats and an additional central seating option with manually heightadjustable headrests • Rear seat backrest divisible in a ratio of 40:20:40 or completely foldable • Center armrest at the rear, one-piece and foldable, with cup holder <p>Forces Perforated leather combination with honeycomb stitching (N0Q) at no cost</p>	R77,800



Optional equipment		e-tron GT
Seats Upholstery Inlays		
N7U	<p>"Dinamica®" microfiber/leatherette "mono.pur550" combination (forces Sport seats plus (Q2)) Dinamica microfibre is a breathable microfibre material with a sporty look. Dinamica microfibre/mono.pur 550 artificial leather combination for sport seats plus, front includes:</p> <ul style="list-style-type: none"> · seat centre panel and inner surface of seat side bolsters for the front seats and the two outer rear seats in Dinamica microfibre, black; seat centre panel with waterfall pattern in black · outer surface of seat side bolsters, head restraints with shoulder area and centre rear seat in mono.pur 550 artificial leather, black 	No cost
N2Y	<p>Fabric "Cascade"/leatherette "mono.pur550" combination (forces Sport seats plus (Q2)) The new Cascade cloth is used for the seat centre panel. Cascade cloth is an innovative material manufactured partly using recycled fibres. It contains recycled PET bottles and textile fibres that are collected and processed in the manufacturer's regional area. A large part of the seat cushioning also consists of recycled PET bottles. Cascade cloth/mono.pur 550 artificial leather combination for sport seats plus, front includes:</p> <ul style="list-style-type: none"> · seat centre panel, inner surface of seat side bolsters and head restraints with shoulder area of the front seats and of the two outer rear seats in Cascade cloth; seat centre panel with waterfall pattern in gloss black · outer surface of seat side bolsters and centre rear seat in mono.pur 550 artificial leather, black 	No cost
N0Q	<p>Perforated leather combination with honeycomb stitching (forces Sport seats Pro Q1J) Leather combination, perforated with honeycomb pattern for sport seats pro, front includes:</p> <ul style="list-style-type: none"> · seat centre panel of the front seats and of the outer rear seats in perforated leather, black with honeycomb pattern in black · seat side bolsters, head restraints and centre rear seat in fine Nappa leather, black <p>Leather combination, perforated with honeycomb pattern for sport seats pro, front is available in additional colours in conjunction with upper and lower interior elements in fine Nappa leather/Dinamica microfibre¹:</p> <ul style="list-style-type: none"> · leather combination in Santos brown with tone-on-tone stitching · leather combination in arras red with contrasting stitching in crescendo red · leather combination in Monaco grey with contrasting stitching in steel grey 	No cost
7HD	<p>Upper and lower interior elements in fine Nappa leather/Dinamica® microfiber For sport seats plus, front and sport seats pro, front, the upper part of the instrument panel with instrument panel cover, the door rails, the door armrests and the centre console are in fine Nappa leather and the door trim inserts are in Dinamica microfibre. In combination with the sport seats pro, front, additional colour combinations in fine Nappa leather/Dinamica microfibre are available for the upper and lower interior elements. The characteristics of the fine Nappa leather accentuate the sophisticated appeal of the vehicle interior. The through-dyed, coated leather tanned without the use of chromium and its surface protection convey a sense of quality and ensure that the material is durable and lightfast. The discreet coating and pleasantly warm, breathable surface underline the luxurious character of the vehicle interior. Dinamica microfibre is a breathable microfibre material.</p>	R33,600
PEH	<p>Black Styling package without leather. (Upper and lower interior elements in leatherette/Dinamica® microfiber 7HF) Completely leather-free interior. The targeted use of resource-friendly materials is a clear statement for the modern automotive world. In a choice of Dinamica microfibre or Cascade cloth in combination with mono.pur 550 artificial leather. Including upper and lower interior elements in artificial leather/Dinamica microfibre as well as a sport contour steering wheel in Alcantara.</p>	R12,000
7TN	Decorative inserts in Gray Brown Natural Walnut wood	R15,500
5MH	Decorative inserts in Matte Carbon Twill	R24,100



Optional equipment		e-tron GT
Suspension systems & brakes		
PHZ	All wheel steering Improved handling: <ul style="list-style-type: none"> · more precise steering behaviour · more direct steering response · excellent driving and directional stability · improved agility Improved driving comfort: <ul style="list-style-type: none"> · comfortable handling · reduced steering angle · smaller turning circle · improved stability when changing lanes and swerving at high speeds 	R27,900
PC5	Ceramic brakes with Anthracite Gray brake calipers	170,100
PC7	Ceramic brakes with Blue brake calipers	180,100
PC6	Ceramic brakes with Red brake calipers	180,100
PC1	Steel brakes with tungsten carbide coating and Black brake calipers	58,100
PC2	Steel brakes with tungsten carbide coating and Orange brake calipers	68,100
PC3	Steel brakes with tungsten carbide coating and Red brake calipers	68,100
GH3	quattro with controlled rear differential lock	R30,100



Optional equipment		e-tron GT
Safety and Assistance systems		
W1G	<p>Adaptive cruise control with speed limiter, efficiency assist, swerve assist and turn assist with Adaptive cruise assist</p> <p>includes:</p> <ul style="list-style-type: none"> · adaptive cruise control for regulating distance · speed limiter for warning the driver when the set maximum speed limit is exceeded · efficiency assist for an anticipatory, efficient driving style · swerve assist for helping the driver avoid obstacles · turn assist for warning the driver of oncoming vehicles and for braking support when turning off <p>Adaptive cruise assist:</p> <ul style="list-style-type: none"> · keeps the vehicle in its own lane · assists by braking, accelerating and steering · regulates the distance to the vehicles in front 	R33,000
PCZ	<p>360-degree cameras + Parking aid Plus with 360° display</p> <p>Four wide-angle surround view cameras capture the entire area immediately around the vehicle. The image data captured by the cameras allows a range of different views controlled via the touchscreen. The surround view cameras are activated by selecting reverse gear. Alternatively, they can be activated via a button on the centre console or a button on the display providing the distance indicator is shown. In conjunction with the surround view cameras, parking system plus with 360° display provides acoustic and visual support when entering and exiting parking spaces as well as when performing forward, side and reversing manoeuvres. This uses data captured by the 12 ultrasonic sensors integrated discreetly into the bumpers. Based on the steering angle and direction of travel, the distance to detected objects is shown in a selective, optical display on the screen. Obstacles detected outside the driving path are shown as a white segment. Red segments represent obstacles in the driving path. A virtual driving path display additionally provides guidelines at the sides, which are calculated in advance based on the current steering angle. The function is activated by selecting reverse gear, via a button on the centre console and, as an option, automatically as soon as the vehicle moves closer to a detected obstacle at a speed below 10 km/h.</p>	S
6I6	<p>Adaptive cruise assist with emergency assist</p> <ul style="list-style-type: none"> · helps to keep the vehicle in its own lane · assists by braking, accelerating and steering · helps to regulate the distance to the vehicles in front · optional triggering of emergency call 	R11,000
6K8	Audi pre sense basic, Audi pre sense front	No Cost
KS1	Head-up display	R28,100
9R1	Night vision assistant	R43,200
PCV	<p>Park Assist package with park assist plus</p> <p>The assist package Park with park assist plus combines assist systems that help when parking and manoeuvring. Park assist plus enables the vehicle to be driven into and out of parking spaces by pressing the >>P button. The vehicle steers, accelerates, brakes and switches off the motor. The driver has to fully monitor this manoeuvre. For even easier manoeuvring, the surround view cameras display a range of different views of the vehicle's immediate surroundings directly on the touchscreen of the vehicle.</p>	R33,500

Vehicle driver assistance and safety systems are not a substitute for attentive driving. Drivers retain full responsibility for providing the necessary inputs for safe control of the vehicle. System descriptions within this brochure are provided for information purposes only. System limitations and operational requirements apply.



Optional equipment		e-tron GT
Exterior equipment		
3FI	Carbon roof	R75,400
VC2	Garage door opener This radio-operated remote control is freely programmable. Users can customise the names given to touchscreen areas for operation. Up to eight different radio-controlled garage doors, exterior gates or security and lighting systems in total can be stored. When approaching the stored location, a relevant pop-up appears to trigger the transmit operation. A user-friendly set-up assistant for the system – complete with the relevant owner’s manual information – is available via the MMI.	R5,000
Charging systems		
73Q	Industrial cable for 3-phase 32A (replaces 73N for 1-phase)	No cost
73P	Industrial cable for 3-phase 16A (replaces 73N for 1-phase)	No cost
NW2 + KB4	AC charging at 22kW, includes: e-tron charging system "connect" up to 22 kW, On-board charger up to 22 kW (AC)	R58,900



Important information

Welcome to Audi

Audi Freeway Plan | Motoring Peace of Mind

There can be no better motoring peace of mind than knowing that your car will be serviced, maintained and repaired, should this prove necessary, at no cost to you. Thanks to Audi Freeway Plan, that peace of mind could be yours.

The Audi Freeway Plan absorbs all maintenance and service costs, with the exception of between-service top-up fluids, fuel, cracked or broken glass, and tyres.

A five-year or 100 000 km Audi Freeway Plan is included as standard on all new Audi vehicles.

Top-up options to extend maintenance up to 10 years, or 300 000 km are available at extremely competitive rates. Audi has specially designed the Audi Freeway Plan for easy operation on the part of the owner. Making an appointment with any one of our approved Audi Servicing Dealers can effect regular servicing and maintenance as well as repairs (with the exception of accident damage).

All work is handled by the relevant service department, which will liaise directly with the Audi Freeway Plan Maintenance Unit. No extra effort or payment is required from the Audi owner. The Audi Freeway Plan is registered with the vehicle and as such is transferable to the new owner should the car be sold before the Audi Freeway Plan has expired, giving added resale value. The Audi Freeway Plan is available in addition to the Audi's standard one-year/unlimited distance vehicle warranty. The Audi Freeway Plan is subject to certain exclusions, covers any repairs necessary after the expiry of the standard warranty.

Audi Assist | Emergency and Personal Assistance

Audi Assist is a programme whereby Audi of South Africa and its Dealer Network pledge to provide you with peace of mind motoring by providing the infrastructure to support a countrywide emergency service 24 hours a day, every day.

The programme is known as Audi Assist and operates within the borders of South Africa as well as Namibia and Botswana. The objective of the programme is to ensure on the spot roadside assistance offered by a fully equipped and trained Audi technician.

The primary focus is to get you mobile in your own vehicle. Where a roadside repair cannot be effected and the vehicle needs to be towed to the nearest Audi dealer, you and the occupants of the vehicle will be transported to a place of safety in the dealer's roadside assistance vehicle.

Contact details within South Africa:

086 043 4838

Contact details for neighbouring states:

+27 41 994 5616

24 hours a day, 7 days a week

Vehicle model and VIN number will be required.

e-tron GT



Audi e-tron GT Dimensions All the measurements you need

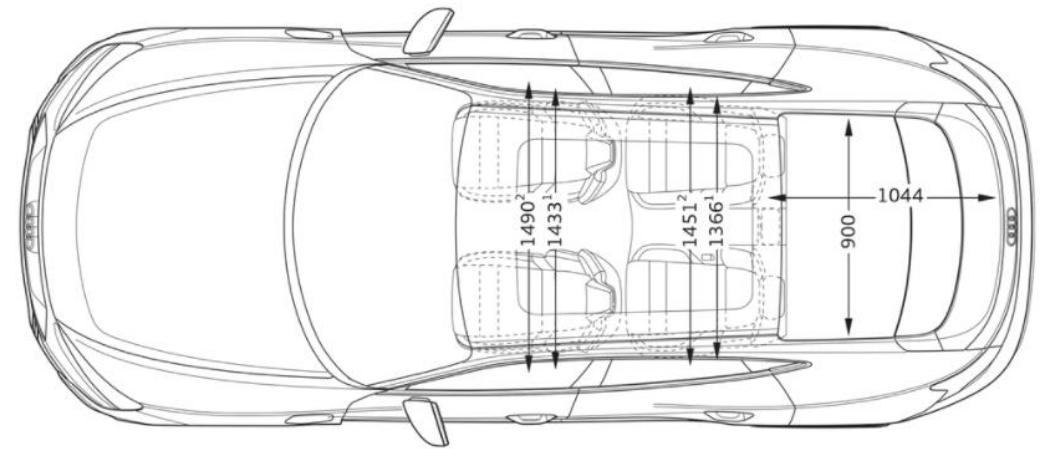
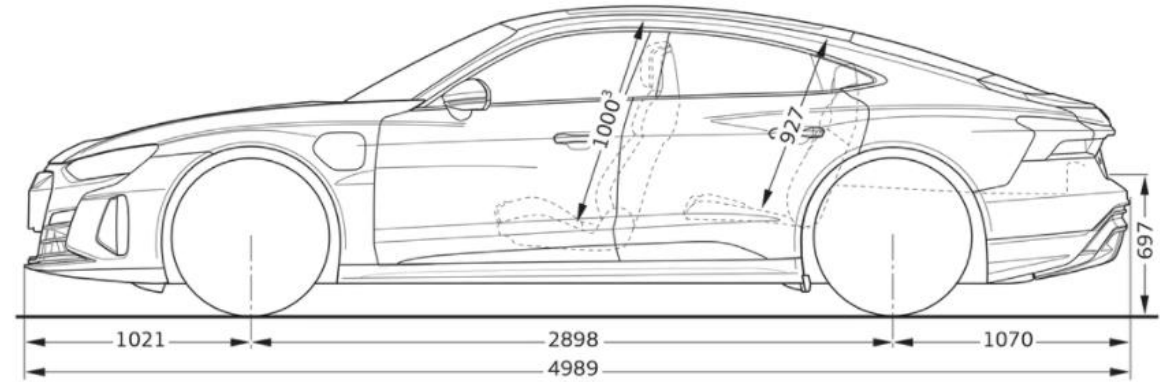
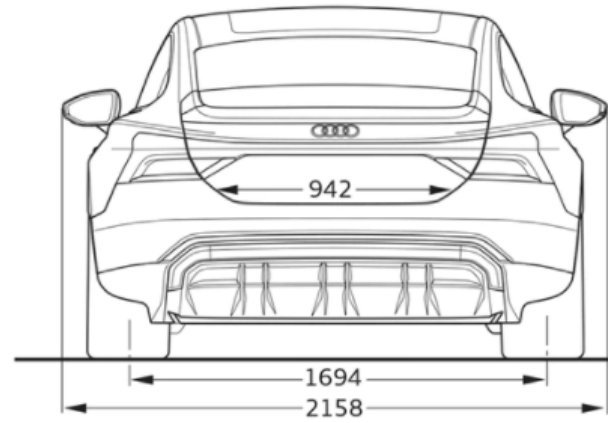
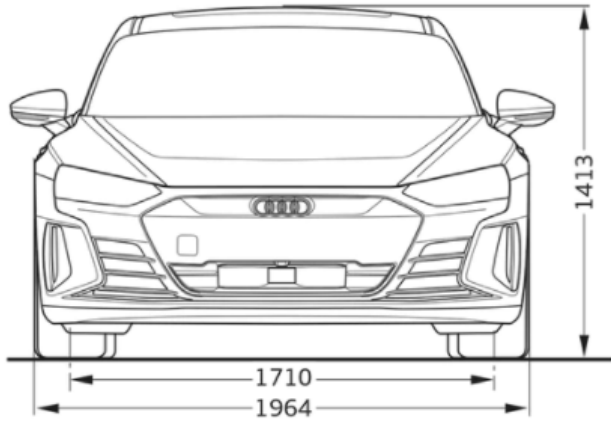

¹Width shoulder space
²Width elbow space
³Maximum head space

Audi e-tron GT luggage compartment capacity - 405L

e-tron GT



Information in this pricelist

We've done all we can to make the prices, specifications, technical details and all other information you see in this pricelist accurate at the time of publication. We reserve the right to change prices or specification at any time. All prices shown include VAT, which is currently charged at 15%. Recommended retail pricing is not binding and is inclusive of a 5 year/100,000km Audi Freeway Plan.

Please check model availability and full specification details with your Audi Dealership prior to ordering. Neither Audi South Africa nor Audi Dealers can accept contractual responsibility for your reliance on the information contained in this pricelist. Performance figures and specifications relating to Audi vehicles are indicative only and performance cannot be guaranteed. Performance figures and specifications may be updated from time to time, when new test results or other information become available. Your local Audi Dealership can always provide you with the most up-to-date information available. Written and visual depictions (including photographs) of vehicles, are for illustrative purposes only and should not be relied upon. Some illustrations may not accurately reflect South African specifications (including paint and trim colours) and may not be available. If in doubt, always contact your local Audi Dealership.