

# Guideline for rescue and recovery personnel

Notes on responding to accidents involving Audi vehicles

Version dated: 03/2025



**Legal notice:**

This guide was created exclusively for emergency and recovery personnel who are specially trained in technical assistance after road accidents and can therefore carry out the activities described in it.

Specifications and special equipment in Audi vehicles, and the range of vehicles made by Audi AG, are subject to constant changes.

Audi therefore explicitly reserves the right to modify or change the content of this guide at any time. The information was up to date at the time it was written.

**Please note:**

The information contained in this guide is not intended for end customers, and also not for qualified workshops and dealerships.

End customers can find information on the functions of their Audi AG vehicle, as well as important vehicle and passenger safety information, in the vehicle wallet. Workshops and dealerships receive repair information from their accustomed sources.

© Copyright, Audi AG, Ingolstadt, 2025

# Contents

List of abbreviations . . . . .	5	Disconnecting the 48-volt vehicle battery . . . . .	37
Preface . . . . .	6	Safety equipment in natural gas vehicles . . . . .	39
<b>0. Rescue card/cards . . . . .</b>	<b>7</b>	<b>4. Access to the occupants . . . . .</b>	<b>41</b>
Area of application . . . . .	9	General instructions . . . . .	42
<b>1. Identification / recognition . . . . .</b>	<b>12</b>	Unlocking the vehicle doors . . . . .	44
Distinguishing features of Audi models . . . . .	13	Electrically assisted door handles . . . . .	45
Distinguishing features of vehicles with combustion engine . . . . .	14	Door handles with sensor surface . . . . .	46
Distinguishing features of high-voltage vehicles . . . . .	15	Body reinforcements . . . . .	48
Sample distinguishing features of high-voltage vehicles . . . . .	16	Glazing . . . . .	51
Classification of the electrification variants . . . . .	18	Driver seat and steering wheel adjustment mechanisms . . . . .	52
Vehicles with a natural gas drive at Audi . . . . .	19	Electric convenience systems . . . . .	53
Distinguishing features of natural gas vehicles . . . . .	19	<b>5. Stored energy / liquids / gases / solids . . . . .</b>	<b>54</b>
<b>2. Immobilisation / stabilisation / lifting . . . . .</b>	<b>20</b>	Vehicles with a high-voltage system . . . . .	56
Preventing the vehicle from rolling away . . . . .	22	High-voltage safety concept . . . . .	57
Lifting the vehicle . . . . .	23	Warning labels for high-voltage components . . . . .	59
<b>3. Disable direct hazards / safety regulations . . . . .</b>	<b>24</b>	The high-voltage battery . . . . .	60
Switching off the ignition . . . . .	26	Hazard warnings . . . . .	65
Deactivating the high-voltage system . . . . .	27	Flammable materials . . . . .	67
Disconnecting from the charging station (manual release) . . . . .	35	Natural gas vehicles . . . . .	68
Disconnecting the 12-volt vehicle battery . . . . .	36	Air conditioning system . . . . .	70
		Compressed air tanks . . . . .	70
		Flammable materials . . . . .	70

**6. In case of fire . . . . . 71**

Vehicle fire . . . . . 72  
Fire in high-voltage vehicles . . . . . 73  
Fire in gas vehicles. . . . . 75

**7. In case of submersion . . . . . 76**

Vehicle under water. . . . . 77  
High-voltage vehicle under water. . . . . 77  
Natural gas vehicle under water . . . . . 77

**8. Towing / transportation / storage . . . . . 78**

Recovering vehicles involved in accidents . . . . . 79  
Recovering high-voltage vehicles involved in accidents from a danger  
area . . . . . 80  
Recovering natural gas vehicles involved in accidents from a danger  
area . . . . . 82

**9. Important additional information . . . . . 83**

Airbag. . . . . 84  
Airbag stored gas inflators . . . . . 89  
Belt tensioners. . . . . 89  
Protective bar. . . . . 93  
Re-active bonnet . . . . . 94  
Sources, further information . . . . . 94

**10. Explanation of pictograms used . . . . . 95**

## List of abbreviations

AC	Alternating current	ISO	International Organization for Standardization
BEV	Battery Electric Vehicle	LPG	Liquefied Natural Gas
CNG	Compressed Natural Gas	MHEV	Mild Hybrid Electric Vehicle
CO <sub>2</sub>	Carbon dioxide	PHEV	Plug-in Hybrid Electric Vehicle, vehicle with a hybrid drive, whose battery can be charged both via the combustion engine and with a charging connector.
DC	Direct current	Pkw	Passenger car
DGUV	German Statutory Accident and Insurance Association	PWR	Pulse inverter
e-tron	Audi models with an electric drive	quattro	Audi models with four-wheel drive
FBFHB	Fire Service-Assistance–Fire Protection department	TDI	Audi models with diesel combustion engine
FCEV	Fuel Cell Electric Vehicle	TFSI	Audi models with petrol combustion engine
g-tron	Audi models with a natural gas drive (CNG)	TFSI e	Audi models with petrol hybrid drive (PHEV)
HEV	Hybrid Electric Vehicle	VDA	German Association of the Automotive Industry
IEC	International Electrotechnical Commission		

## Preface

The driver, the vehicle and the surroundings are the three key factors whose interaction is decisive for road safety.

The vehicle has a number of tasks when an accident occurs, including:

- Keeping the passenger compartment as rigid as possible to ensure a space for survival
- Dissipating the impact energy using intelligent structural concepts and elements
- Using an optimised restraint system – consisting of airbags and seat belts with belt tensioners and belt force limiters – to effectively protect the occupants
- Using safety systems to minimise the hazards from service fluids and powertrain components

Audi vehicles have proven in international tests that they are among the safest. However, accidents and the associated injuries can never be ruled out. This means a short, fast and effective chain of rescue is as essential as ever.

This guide was created in accordance with ISO 17840 and is intended to help emergency and recovery personnel do their jobs by providing the necessary information on the technology used in Audi vehicles.

Technical innovations such as new materials or new drive technologies require

a modified approach when performing a rescue from a vehicle that has been in an accident.

The processes and procedures in the different countries around the world are usually governed by official instructions or guidelines issued by legislators, or the rescue organisation itself. If information about the procedure is provided in this guideline for rescue services, this should be considered as suggestions only for this reason.

The information is intended in particular for the training and development of emergency and recovery personnel. Appropriate rescue cards for Audi vehicles are available for use at the scene of an accident.

The latest version can be found at [www.audi.com/rescue](http://www.audi.com/rescue)

# **0. Rescue card/ cards**

## 0. Rescue card/cards

Audi provides rescue cards for all vehicle models and variants.

The Audi brand provides information on accident recovery processes for all models. The individual rescue cards can be downloaded directly from [www.audi.com/de/rescue.html](http://www.audi.com/de/rescue.html). After marking a rescue card, the desired language can be selected.









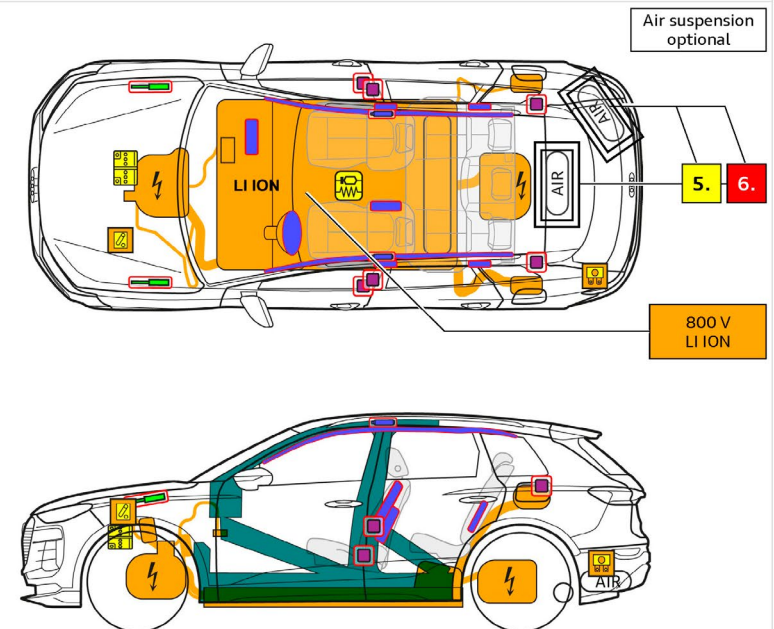





The illustration shown here includes an example of the first page of the rescue card for the Audi Q6 e-tron in accordance with ISO 17840-1:2022.

The rescue cards for all vehicles with a market launch from 2020 onwards have been created in accordance with ISO 17840. The rescue cards for vehicles launched prior to this feature the manufacturer's layout.

From 2023, all newly created rescue cards will be published in all European languages.

 **Audi Q6 / SQ6 e-tron**  
SUV, from 2024  
5-door, 5-seater



	Airbag		Stored gas inflator		Seat belt pretensioner		SRS control unit		Gas strut / Preloaded spring
	High strength zone		Battery pack, low voltage		Battery pack, high-voltage		High voltage power cable		Low voltage device that disconnects high voltage
	Fuse box disabling high voltage		High voltage component		Air tank		Zone requiring special attention		

Additional information

Document number

Version

Page



## Area of application

This guide for emergency and recovery personnel is valid for all vehicles made by the Audi brand.

The model portfolio is extensive, spanning compact cars to sports vehicles, and includes vehicles with petrol and diesel engines and natural gas, hybrid and all-electric drives.

The most important recent Audi models are shown by way of example on this page and the following pages.

The current Audi model range can also be accessed on the website [www.audi.de](http://www.audi.de). The model range may differ from the variants shown depending on the country.

### Identification of drive types



Vehicle on fuel of liquid group 2



Vehicle on fuel of liquid group 1



Vehicle on CNG



Hybrid Electric Vehicle on fuel of liquid group 2



Electric vehicle

The vehicle-specific drive types are described on the rescue cards.

### Sample Audi model range

## A1



A1 Sportback, A1 allstreet

## A3



A3/S3/RS 3 Sportback  
A3 allstreet



A3/S3/RS 3 Saloon

## A4

Up to 2024



A4/S4 Saloon



A4/S4/RS 4 Avant  
A4 allroad quattro

## A5

Up to 2024



A5/S5/RS 5 Coupé



A5/S5/RS 5 Sportback



A5/S5 Cabriolet

Sample Audi model range

**A5**

from 2024



A5/S5 Saloon



A5/S5 Avant

**A6**



A6/S6 Avant



A6/S6/RS 6 Saloon

**A6  
e-tron**

from 2024



A6/S6 e-tron Sportback



A6/S6 e-tron Avant

**A7**

Up to 2025



A7/S7/RS 7 Sportback

**A8**



A8/S8



A8 L

Sample Audi model range

**Q2**



Q2/SQ2

**Q3**



Q3/RS Q3



Q3/RS Q3 Sportback

**Q4  
e-tron**



Q4 e-tron



Q4 Sportback e-tron

**Q5**



Q5/SQ5



Q5/SQ5 Sportback

**Q6  
e-tron**



Q6/SQ6 e-tron

Sample Audi model range

Q7



Q7/SQ7

Q8



Q8/SQ8/RS Q8

Q8  
e-tron

Up to 2025



Q8/SQ8 e-tron



Q8/SQ8 Sportback e-tron

e-tron

Up to 2023



Audi e-tron (high-voltage)



Audi e-tron Sportback

e-tron  
GT



S/RS e-tron GT

Sample Audi model range

TT

Up to 2024



TTS/TT RS coupé



TTS Roadster

R8

Up to 2023



R8 Coupé V10 performance



R8 Spyder V10 performance

# 1. Identification / recognition

## Distinguishing features of Audi models

Along with the Audi logo with the four rings, the individual models can be identified by the respective body shape, body size and the individual vehicle design. In addition, the model designation and the technology lettering on the rear of the vehicle can help with identification. This lettering is not present, however, if it was cancelled in the vehicle order or was subsequently removed. The illustrations on this page show examples of how the logo and the lettering are attached.

The current Audi model range can also be found on the website [www.Audi.com](http://www.Audi.com).

### Audi logo



Audi logo in the radiator grille



Audi logo on the boot lid

### Model designation



Model designation on the rear of the vehicle



For the new models introduced from 2023:  
Model designation on the B-pillar



### Distinguishing features of vehicles with combustion engine

Audi models with conventional combustion engines (petrol/diesel) can be identified by the following features.

The vehicle-specific distinguishing features are described on the rescue cards.

Lettering and type designations may be missing.

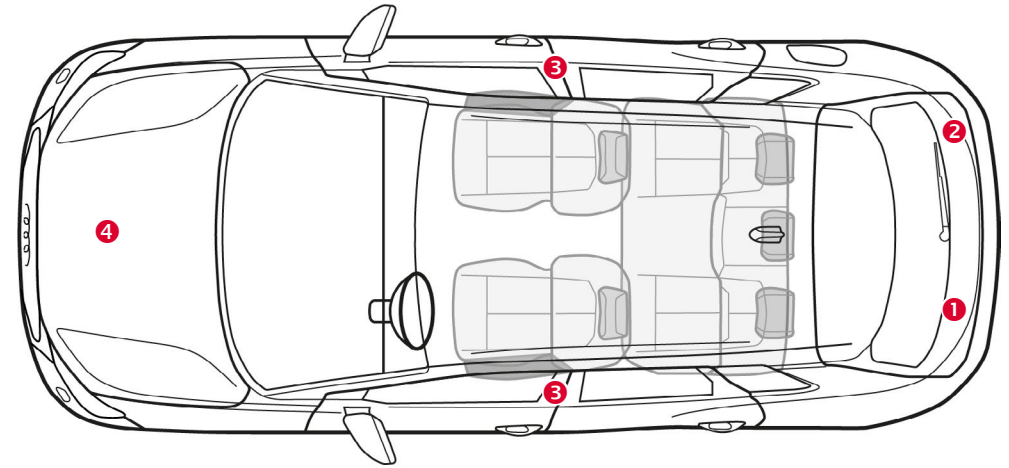

#### Features on the vehicle

- 1 Model designation
- 2 Model-specific lettering such as “TFSI”, “TDI” or “quattro”
- 3 For the new models introduced from 2023: model designation on the B-pillar
- 4 Lettering such as “TFSI” or “TDI” on the engine cover panel



### Distinguishing features of high-voltage vehicles

Audi models with a high-voltage drive are available with a plug-in hybrid drive (PHEV) or a fully electric drive (BEV).



The electric drive motor is silent. The display in the instrument cluster (power meter) indicates whether the electric drive is switched off (OFF) or ready for operation (READY).

The vehicle-specific distinguishing features are described on the rescue cards.

Lettering and type designations may be missing.

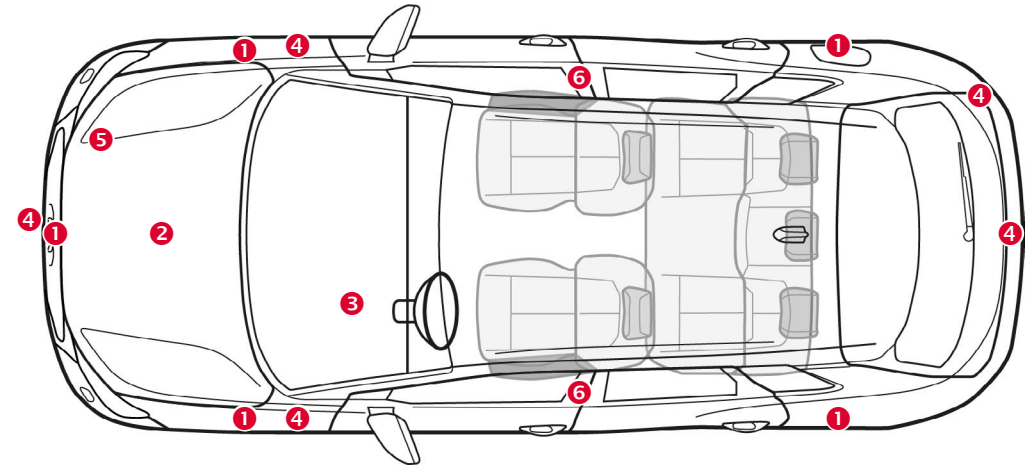

### Features on the vehicle

- ① Charging sockets in the radiator grille or in the front or rear wings
- ② Orange-coloured cables in the engine compartment
- ③ e-specific displays in the instrument cluster, such as charging displays, power display “READY” for the vehicle’s drive system
- ④ “e-tron”, “TFSI e” or “e-hybrid” lettering on the outside of the vehicle
- ⑤ Warning stickers in the engine compartment
- ⑥ For the new models introduced from 2023: model designation on the B-pillar

## Sample distinguishing features of high-voltage vehicles

### Features on the outside of the vehicle

- Model designation “e-tron” or technology lettering “TFSI e” or “e-hybrid”:  
the current Audi high-voltage vehicles can be identified by the model lettering “e-tron” (all-electric vehicles) or by the technology lettering “TFSI e” or “e-hybrid” (plug-in hybrid). Earlier full-hybrid models from Audi are recognisable by the “hybrid” model lettering.
- External charging connection for the high-voltage battery:  
The charging socket cover with charging socket is located either on the wing panel or on the rear side section. On the A3 e-tron (2014 to 2020), the charging socket flap is integrated into the radiator grille behind the Audi rings.
- “E” label on the number plate (only in Germany, only if ordered by the customer)

### Model designation and technology lettering



“e-tron” lettering on the boot lid



“TFSI e” lettering on the boot lid of plug-in hybrid models

### Model designation and technology lettering



“e-hybrid” lettering on the side of plug-in hybrid models



For the new models introduced from 2023: Model designation “e-tron” or “TFSI e” on the B-pillar



“e-tron” lettering on vehicle front/rear or on the side of the vehicle



“hybrid” lettering on the boot lid in the older full-hybrid models

**The lettering for the model designation and drive technology differs between models and can be deselected during the ordering process. It may also have been removed by the vehicle owners.**



### Charging connection on high-voltage vehicles



“e-tron” charging socket on the wing or side panel (possible on both sides)



Charging socket A6 (up to 2025) “TFSI e” on the rear side panel

## Classification of the electrification variants

After an accident, electrified vehicles pose different hazards to emergency and recovery services than those presented by conventionally powered vehicles. This makes it crucial to identify these vehicles as soon as possible.

Audi offers various electrification variants, which differ in terms of primary energy source, voltage, type of driving machine and electric range.

A distinction is made between the following variants without external charging socket:

- Mild-Hybrid Electric Vehicle (MHEV)
- Full-Hybrid Electric Vehicle (HEV)

and the following variants with external charging socket:

- Plug-In Hybrid Electric Vehicle (PHEV)
- Battery Electric Vehicle (BEV)

The different electrification concepts are shown in the table.

Mild-hybrid vehicles (MHEV) with electrical system voltages of up to 48 volts are not high-voltage vehicles. These vehicles also do not differ externally from the conventional Audi vehicles of the respective model.

All other variants listed are high-voltage vehicles.

### Legend for energy sources











Conventional fuels such as petrol and diesel



Battery operation



Battery operation with charging option via socket

	Mild hybrid (MHEV)	Full hybrid (HEV)	Plug-in hybrid (PHEV)	Battery Electric Vehicle (BEV)
Voltage	12-48 V	200-300 V	300-450 V	300-950 V
Electric drive motor	10-15 kW	20-50 kW	60-120 kW	> 150 kW
Electric driving range		approx. 3 km	approx. 50 - 100 km	> 200 km
Energy source	 	 	  	 
Examples	A3 A4 A5 A6 A7 A8 Q5 Q7 Q8	Q5 hybrid A6 hybrid A8 hybrid	A3 TFSI e Q7, Q8 TFSI e Q5 TFSI e A6, A7, A8 TFSI e A5 e-hybrid	e-tron Q4 e-tron Q6 e-tron Q8 e-tron e-tron GT



## Vehicles with a natural gas drive at Audi

A number of points distinguish vehicles with a natural gas drive from conventional vehicles. It is therefore important to recognise these vehicles during rescue operations so that hazards can be assessed at the scene and suitable measures can be taken.

Audi offers various vehicle models with a combined petrol and natural gas drive.

In addition to several natural gas tanks, natural gas vehicles from Audi are also equipped a small petrol tank.



**Natural gas (also referred to as CNG – compressed natural gas) must not be mistaken for LPG – liquefied petroleum gas. Liquefied petroleum gas and liquefied petroleum gas systems are fundamentally different to natural gas and natural gas systems.**

## Distinguishing features of natural gas vehicles

### Features on the outside of the vehicle

- Model designation or technology lettering “g-tron”
- External natural gas connection, integrated next to the tank filler neck

---

### Distinguishing features of natural gas vehicles



“g-tron” lettering on the boot lid



Natural gas connection on tank filler neck



“g-tron” lettering in the engine compartment

# **2. Immobilisation / stabilisation / lifting**

Stabilising or securing a vehicle reduces the risks that may result from unwanted movements of the vehicle after an accident.

The modern vehicle systems such as start/stop system or Auto Hold function (HOLD button) or new silent drive systems convey the impression that the vehicle is switched off.

However, depending on the accident situation, these systems could lead to the vehicle starting and rolling away unintentionally.

It is therefore recommended to ensure that the ignition is OFF or the power meter is OFF before starting the rescue operation. For more information, see chapter 3. *Disable direct hazards / safety regulations.*

Depending on the situation, it is also recommended to secure the vehicle against unwanted movements (rolling, tilting, slipping) by means of wheel chocks, suitable supports or the attachment of slings.

**When the 12-V vehicle battery has been disconnected, all functions of the electrical system stop working (this applies in particular to the hazard warning lights and electric seat adjustment).**

**For further information, see chapter 4. *Access to the occupants and chapter 9. Important additional information.***



**In some Audi vehicles, the drive system is automatically deactivated after detection of an accident in which airbags are triggered.**



**In high-voltage vehicles, one accessible high voltage device that disconnects high voltage should always be opened to de-energise the high-voltage system. Also see chapter 3. *Disable direct hazards / safety regulations.***

**The recommended procedure is described in the vehicle-specific rescue cards.**

## Preventing the vehicle from rolling away

Audi models are equipped with either a manual gearbox or an automatic gearbox.

To prevent the vehicle from rolling away or unintentionally moving off, the first step is to move the gear lever to the “Neutral” position in vehicles with a manual gearbox and the selector lever to the “P” position in vehicles with an automatic gearbox. In automatic vehicles without a selector lever, press the “P” button.

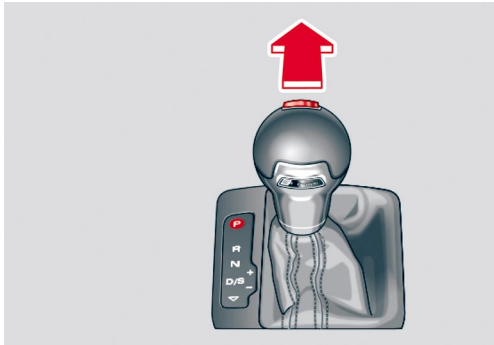

Vehicles with an automatic gearbox and selector lever: move selector lever to position “P”

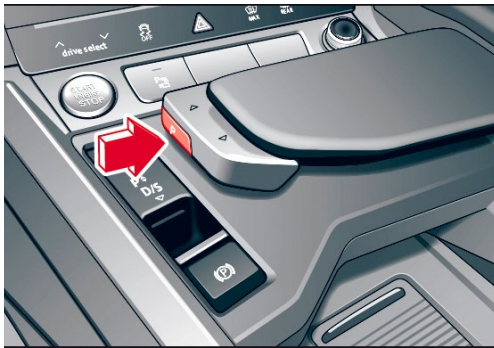

Vehicles with an automatic gearbox without a selector lever: press the “P” button



Vehicles with an automatic gearbox without a selector lever: press the “P” button

In the second step, the mechanical or electric parking brake must be located and operated. The electric parking brake switch is usually located next to or behind the gear lever/selector gate and is operated by “pulling”.



Electric parking brake switch

### Lifting the vehicle

Lifting the vehicle may be necessary to rescue injured persons. Make sure that sensitive parts such as the high-voltage battery, drive train, fuel tank or exhaust system are not damaged if possible.



For vehicles damaged in an accident, the emergency and recovery personnel on site must decide at which points to lift the vehicle.

The vehicle-specific points for lifting are indicated on the rescue cards.

If possible, lift the vehicle at the indicated lifting points.

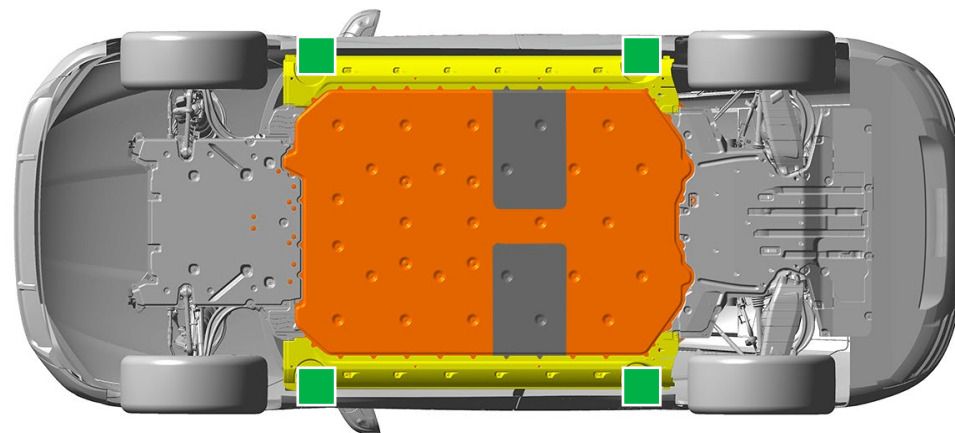

Appropriate lifting points using the Audi e-tron GT as an example

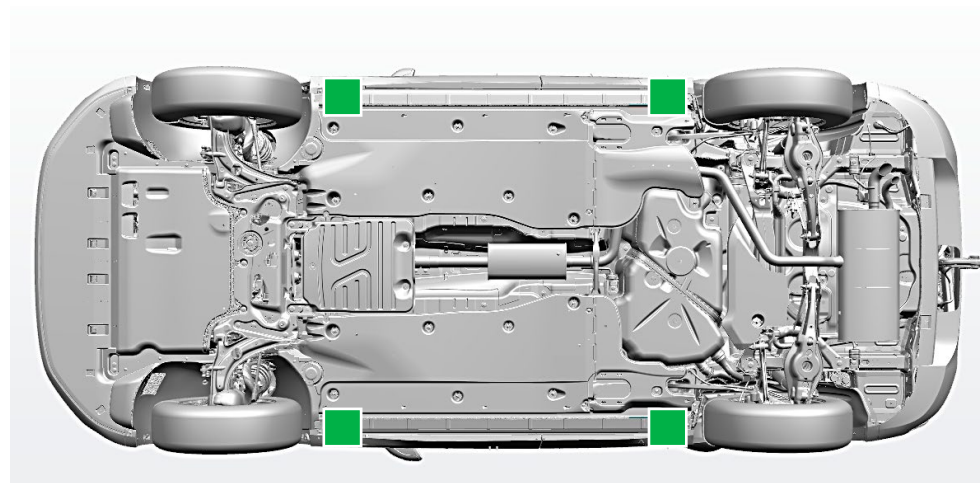

Suitable lifting points using the Audi A5 as an example

 Suitable lifting points

 High-voltage battery

# **3. Disable direct hazards / safety regulations**



Recognition and elimination of hazards to life and limb plays a major role in dangerous situations. This chapter describes the appropriate preventive measures that minimise the risks to accident victims and rescue personnel.



**Wear appropriate protective clothing as liquids or gases may leak and cause injury or explosion.  
Avoid contact with these substances as much as possible during rescue and recovery operations.**

In hazard situations, the following procedure is recommended:

1. Warn surroundings about hazards  
(switch on hazard warning lights, automatic activation after an accident)
2. Immobilise the vehicle, see chapter 2. *Immobilisation / stabilisation / lifting*
3. Disable direct hazards  
*Switching off the ignition*
4. De-energise the electrical system  
*Deactivating the high-voltage system  
Disconnecting the 12-volt vehicle battery  
Disconnecting the 48-volt vehicle battery*

**In the event of an accident in which airbags are triggered, the high-voltage system and the 48-volt electrical system are automatically deactivated. The high-voltage system is de-energised approx. 20 seconds after deactivation.**

## Switching off the ignition

In vehicles with an ignition lock, the ignition is switched off by turning the ignition key towards the occupant and into “position 0”, as shown in the picture.

No conventional ignition lock is installed in vehicles with a keyless locking and starting system. All the driver has to do is carry the vehicle key with them (Keyless Entry and Keyless Go).

The START ENGINE STOP button is used to switch the ignition on or off and to start or stop the engine.

The START ENGINE STOP button is located in the centre console or in the dash panel.

In some vehicles, the ignition is already switched on when the driver enters the vehicle with the key and depresses the brake pedal or closes the driver’s door.

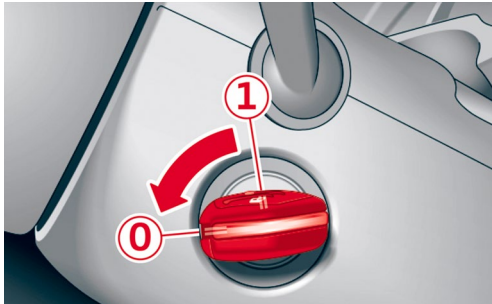

Vehicle with an ignition lock



START ENGINE STOP button



The electric drive motor is silent in vehicles with a high-voltage drive. The display in the instrument cluster (power meter) indicates whether the electric drive is ready for operation (READY) or switched off (OFF).



If the START ENGINE STOP button is pressed and the brake pedal is depressed at the same time, the vehicle may switch to driving readiness mode. Observe the information on the rescue cards.



In some vehicles, the vehicle’s drive system is already activated if a gear is selected while the brake pedal is depressed at the same time.



Instead of the ignition key, use of a key card or smart-phone app is also possible. Remove the ignition key, key card or smartphone from the vehicle after switching off the ignition in order to avoid accidentally switching the ignition on again! A minimum distance of 5 m should be observed!





## Deactivating the high-voltage system

Audi models with battery-electric drive (BEV) or plug-in drive (PHEV) are equipped with a high-voltage system with a voltage of over 300 volts.

The high-voltage system is automatically deactivated in the event of accidents that result in airbag triggering. The high-voltage system is de-energised approx. 20 seconds after deactivation and irreversibly disconnected from the high-voltage battery.

In all other cases, an emergency cut-out connection can be used to deactivate the high-voltage system.  
In particular, using an emergency cut-out connection prevents the system from switching on again.

As a rule, there are at least two emergency cut-out connections, one in the vehicle front end and one in the interior or luggage compartment. At least one of these should be accessible regardless of the accident scenario. These emergency cut-out connections indicated by yellow tags only carry the 12-volt electrical system voltage, which means they can be safely disconnected by the emergency personnel using the procedure described on the tags.



Disconnection of a marked emergency cut-out connection only disables the high-voltage system. Safety systems such as airbags or belt tensioners are still supplied with voltage by the 12-volt electrical system.



The electric drive motor is silent in vehicles with a high-voltage drive. For this reason, in the case of high-voltage vehicles, it is particularly important to deactivate the vehicle in order to prevent it from being switched on again.



Even after disabling the high-voltage system, there is still voltage inside the high-voltage battery. The high-voltage battery must therefore neither be damaged nor opened during the rescue measures.



Do not touch damaged high-voltage components, and cover them using suitable means if necessary!  
Wear personal protective equipment in accordance with the local standards!

The positions of the emergency cut-out connections and the procedure for disabling the vehicle are shown on the Audi rescue cards.

#### At the scene of the accident

Depending on the accident situation, restraint systems or airbags may have been triggered. The officer in charge at the scene of the accident decides how to proceed with the rescue and recovery.



**Rapid or strong smoke development on the accident vehicle may indicate a thermal reaction of the high-voltage battery, see also [Fire in high-voltage vehicles](#).**

#### Minor accident

Initially, no damage is visible and the restraint systems have not been deployed. Recommended course of action:

1. Warn surroundings of hazards:  
switch on hazard warning lights
2. Immobilise the vehicle  
(see chapter 2. [Immobilisation / stabilisation / lifting](#))
3. Deactivate the high-voltage system by triggering at an emergency cut-out connection

#### Severe accident

The restraint systems are activated and the airbags have been deployed. There is initially no visible damage to the high-voltage battery. Recommended course of action:

1. Warn surroundings of hazards:  
switch on hazard warning lights
2. Immobilise the vehicle  
(see chapter 2. [Immobilisation / stabilisation / lifting](#))
3. The high-voltage system was deactivated automatically



**Damage or deformation of the high-voltage battery on the accident vehicle may indicate a thermal reaction of the high-voltage battery, see also [Fire in high-voltage vehicles](#).**

**Depending on the accident situation, it may be necessary to deactivate the high-voltage system manually at an emergency cut-out connection.**

#### Parked or stationary vehicle

If a parked vehicle is damaged by an accident, restraint systems or airbags are generally not triggered. The high-voltage system is not automatically deactivated. When the ignition is switched off, no warnings can be displayed on the dash panel. Recommended course of action:

1. Deactivate the high-voltage system by removing the fuse at the fuse carrier.

#### Vehicle at charging station

If a charging vehicle is damaged by an accident, restraint systems or airbags are generally not triggered. The high-voltage system is not deactivated automatically. When the ignition is switched off, no warnings can be displayed on the dash panel. Recommended course of action:

1. Disconnect charging cable as usual (see Owner's Manual of the vehicle).
2. Alternatively [Disconnecting from the charging station \(manual release\)](#)

### 3. Disable direct hazards / safety regulations

The high-voltage components are marked with warning signs, see also **Distinguishing features of high-voltage vehicles**. High-voltage cables are orange.

#### Identification of emergency cut-out connections

The emergency cut-out connections for deactivating the high-voltage system are uniformly marked on the models in the Volkswagen Group. The pictograms on the labels explain the procedure.

Until 2022, the labels were produced according to our own specifications and installed in the models. From 2023, new labels coordinated with EURO NCAP will be used. These labels will also be used for all Audi models in the future.

#### Previous identification

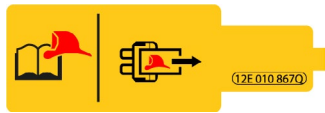

Indicates the emergency cut-out connection in the passenger compartment (pulling out the fuse on the fuse carrier)

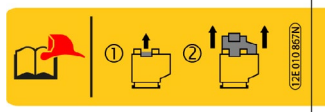

Indicates the emergency cut-out connection in the engine compartment (opening the maintenance connector for high-voltage system)

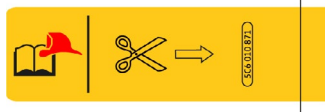

Indicates the emergency cut-out connection in the luggage compartment or rear of the vehicle (cutting through the marked cable)

#### New identification as of 2023

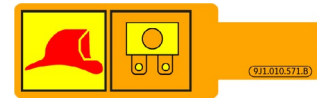

Indicates the emergency cut-out connection in the passenger compartment (pulling out the fuse on the fuse carrier)



Indicates the emergency cut-out connection in the engine compartment (opening the maintenance connector for high-voltage system)



Indicates the emergency cut-out connection in the luggage compartment or rear of the vehicle (cutting through the marked cable)

### 3. Disable direct hazards / safety regulations



#### Disconnecting the high-voltage system from the vehicle



The electric drive motor is silent in vehicles with a high-voltage drive. The display in the instrument cluster (power meter) indicates whether the electric drive is switched off (OFF) or ready for operation (READY).  
Observe the information on the rescue cards.

There are at least two cut-out connections in current Audi models. One is in the vehicle front end, and another is installed in the fuse carrier. There is an additional third cut-out connection in the rear of the vehicle in some vehicles.

Different procedures may be necessary, depending on the vehicle type and equipment. The way in which the vehicle is disabled depends on the accident situation and the vehicle equipment.

**Maximum certainty that the vehicle and, most importantly, the high-voltage system is deactivated can only be provided if an emergency cut-out connection provided by the manufacturer is disconnected and the 12-volt electrical system battery is disconnected.**

#### Use rescue equipment with caution and consideration near high-voltage components

Regardless of whether the vehicle is a hybrid or electric vehicle, the following points always apply in rescue operations at high-voltage vehicles.



Improper handling of high-voltage components can prove fatal due to high voltage and the associated potential flow of current through the human body.



Do not perform any work on badly damaged high-voltage components. One of the accessible emergency cut-out connections should also be opened.  
If the airbags have not deployed, the vehicle must be disabled by the emergency and recovery personnel using an emergency cut-out connection. The high-voltage system has been de-energised after approx. 20 seconds.  
If the airbags have deployed, the high-voltage system will have already been switched off; this means the emergency and recovery personnel can act immediately.



Even after disabling the high-voltage system, there is still electrical energy inside the high-voltage battery. The high-voltage battery must therefore neither be damaged nor opened during the rescue measures.  
If the high-voltage battery has been damaged due to the effects of an accident, avoid any contact with the high-voltage battery or with any liquids and vapours escaping from the high-voltage battery.



Do not touch damaged high-voltage components, and cover them using suitable means if necessary!  
Wear personal protective equipment in accordance with the local standards!



## Emergency cut-out connection in the engine compartment

The “low-voltage service disconnect” in the engine compartment is used as an emergency cut-out connection for high-voltage systems in plug-in hybrid electric vehicles (PHEV) and electric vehicles (BEV). The connector has a green connector housing and a tab for release. The connector is clearly identified as an emergency cut-out connection by a yellow label on the connection cable. The connector is identified with the “emergency cut-out connection” symbol on the rescue card.

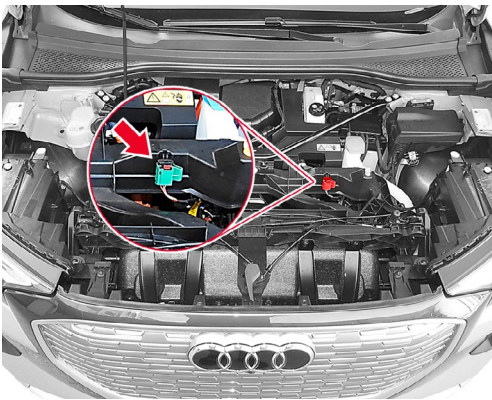

Cut-out connection in the engine compartment of the Audi Q4 e-tron

Procedure for deactivating the high-voltage system using the emergency cut-out connection:



Pull out red tab



Press and hold the red tab and, while doing so, pull out the back connector until it locks in position.

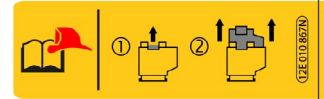

Label for the emergency cut-out connection in the engine compartment



New identification of the emergency cut-out connection in the engine compartment from 2023

The installation location of the emergency cut-out connections and the required procedures can be found on the Audi rescue cards.

### 3. Disable direct hazards / safety regulations

#### Emergency cut-out connection on the fuse carrier

A further emergency cut-out connection is located on the fuse carrier (in the interior in the dash panel area or in the luggage compartment); the respective fuse is marked with a yellow flag. In this case, the high-voltage system is disconnected and deactivated by pulling the labelled fuse out of its holder.

The connectors in the high-voltage battery are opened and disconnected from the rest of the high-voltage system, which is then de-energised after 20 seconds have passed.

The installation location of the emergency cut-out connections and the required procedures can be found on the Audi rescue cards.

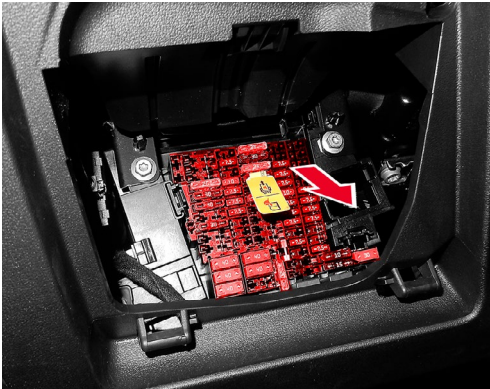

Emergency cut-out connection, fuse carrier

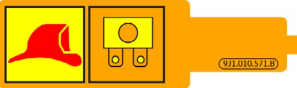
	<b>Label on the emergency cut-out connection in the passenger compartment or luggage compartment (fuse in carrier)</b>
	<b>New identification of the emergency cut-out connection on the fuse carrier from 2023</b>



### 3. Disable direct hazards / safety regulations



#### Emergency cut-out connection at rear of vehicle

In some models, there is an additional cut-out connection in the rear area. In this case, a cable labelled with a yellow tag must be cut.

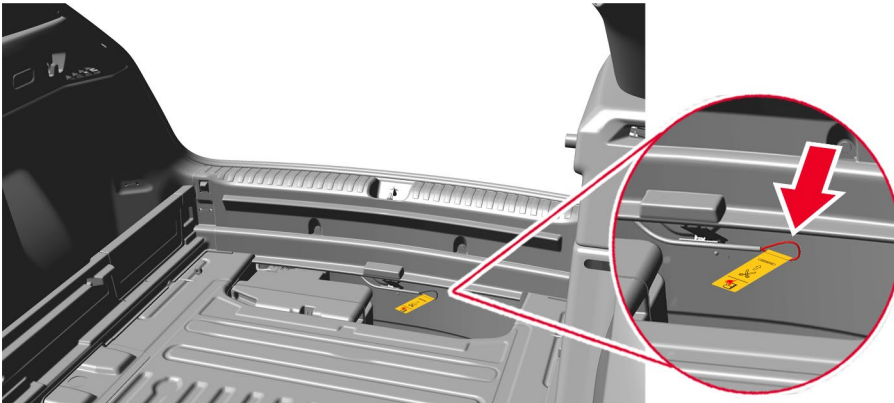

Cut-out connection in the Q4 e-tron luggage compartment under the luggage compartment floor at the rear cross panel.  
The yellow tag indicates the cut-out connection.

The installation location of the emergency cut-out connections and the required procedures can be found on the Audi rescue cards.



Label of the emergency cut-out connection in the luggage compartment or at the rear of the vehicle



New identification of the emergency cut-out connection on the rear of the vehicle from 2023

### 3. Disable direct hazards / safety regulations



#### High-voltage service disconnection in the Q5 hybrid, A6 hybrid, A8 hybrid

The hybrid vehicles (HEV) Q5 hybrid (2011–2016), A6 hybrid (2012–2015), A8 hybrid (2012–2017) have a different type of high-voltage service disconnection connector.

This high-voltage service disconnection connector is located in the middle of the luggage compartment floor under a flap that must be opened. Remove the orange rubber protective cap underneath. The exact location can be found in the rescue cards.

The images show how this high-voltage service disconnection connector is operated. Firstly, the lever is pulled backwards; secondly, it is folded upwards and pulled out upwards.



Pull the lever backwards

Fold the lever upwards and pull out the plug upwards.



## Disconnecting from the charging station (manual release)

High-voltage vehicles are generally charged when parked. The charging stations can be located in public car parks, private carports/garages or public charging stations or charging facilities.

The conditions of the infrastructure in question must be taken into account by emergency and recovery personnel called out to emergencies and fires when assessing the situation and deciding which measures to take.



Public charging stations are generally connected to the public power grid at more than 1,000 volts. In the event of a fire, correspondingly greater safety distances must be maintained here.

**The procedure for vehicle-side manual release of the charging connector is described in the rescue cards.**

Another difference is the type of charging voltage. Some systems charge with alternating current while others charge with direct current. A system that uses direct voltage (DC) supplies the battery directly via the charging socket. If the high-voltage battery is charged with alternating voltage (AC), the charger in the vehicle takes over the function of the voltage converter.



Observe the existing regional and national contingency plans for emergency and recovery personnel at public charging stations.



The charging connections and the appearance of public and private charging stations differ depending on the manufacturer and country.



## Disconnecting the 12-volt vehicle battery

The increasing number of equipment options for vehicles means the number of energy consumers has increased, and with them the need for several energy storage units.

This also affects the emergency services, because there are more issues to be taken into account, particularly when disabling the vehicle electrical system (switching off the ignition, disconnecting the vehicle batteries).

Disabling the vehicle electrical system not only reduces the risk of fire caused by short circuits, but also the risk of delayed deployment of airbags, belt tensioners or protective bars.

When deactivating the vehicle electrical system, it must also be ensured that the power supply to any trailers attached is disconnected and any solar elements in the sliding sunroof are covered.



**After disconnecting the 12-volt electrical system, all airbags are deactivated. Unignited airbags can be triggered by heat in the event of a fire!**

**When the 12-V vehicle battery has been disconnected, all functions of the electrical system stop working (this applies in particular to the hazard warning lights and electric seat adjustment).**

**For further information, see chapter 4. Access to the occupants and chapter 9. Important additional information.**

Depending on the type of vehicle and equipment, one or more 12-volt vehicle batteries may be installed.

The location of the 12-volt battery/batteries can be found in the rescue card.

If the battery is to be completely disconnected, the ground/negative terminal must be disconnected otherwise there is a risk of short circuit. The negative terminal must be protected against re-contact (insulate, tie away, bend away etc.). If the battery is disconnected, a check must be performed as to whether the vehicle is actually de-energised. This may be indicated by the hazard warning lights or interior lighting going out.

**The position(s) of the 12-volt battery/batteries is/are shown in the rescue cards.**

**In the case of batteries with a pyrotechnical separator, the battery also has to be disconnected in order to completely de-energise the vehicle.**

In vehicles with 48-volt or high-voltage technology, the 48-volt battery must also be disconnected in addition to the 12-volt battery or the high-voltage system deactivated in order to de-energise the vehicle completely. Please refer to the information on the following pages.



## Disconnecting the 48-volt vehicle battery

Today's vehicles feature intelligent drive systems and a variety of driver assist systems. Depending on the model type and equipment, these vehicles are operated by an additionally installed 48-volt electrical system with a lithium-ion battery in addition to the 12-volt electrical system.

A number of examples of use are:

- Roll stabilisation
- Advanced start/stop mode with help from a belt-driven starter-alternator

These vehicles belong to the Mild-Hybrid Electric Vehicle (MHEV) category. Mild-hybrid vehicles with electrical system voltages of up to 48 volts are not high-voltage vehicles.



**Switch off the ignition before disconnecting the batteries!**



**When disconnecting the 48-volt battery, there is a danger of an electric arc!  
Wear appropriate personal protective equipment!**

**In the event of an accident in which airbags are triggered, the 48-volt electrical system is automatically disabled.**

**In all other cases, the 48-volt lithium-ion battery must also be disconnected in addition to the 12-volt lead battery in order to deactivate the entire electrical system.**

The following general rules apply here:

- 1) Switch off the ignition before disconnecting the batteries!
- 2) After locating the batteries (see rescue card), first disconnect the negative terminal on the 12-volt vehicle battery (see [Disconnecting the 12-volt vehicle battery](#))!
- 3) Then disconnect the 48-volt lithium-ion battery! Here, disconnecting the communication plug before disconnecting the negative terminal is recommended.



### Disconnecting the 48-volt vehicle electrical system in an Audi A4 (2020)

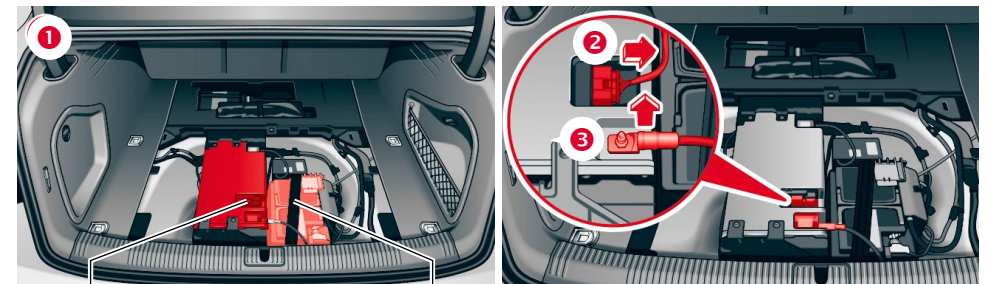

48-volt battery

12-volt

**1** Locate the batteries

**2** Disconnect the communication connector

**3** Disconnect the negative terminal on the 48-volt vehicle battery

### 3. Disable direct hazards / safety regulations

#### Disconnecting the 48-volt vehicle electrical system in an Audi A3 (2020)

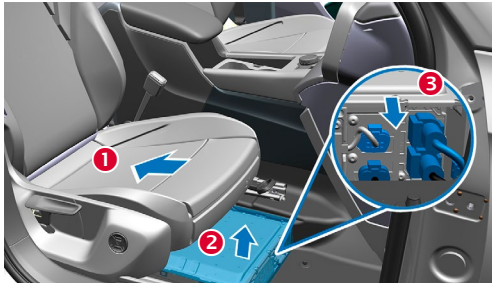

- 1 Move the front right-hand seat in the passenger compartment to the rear
- 2 Remove the battery cover
- 3 Unplug all connectors

In addition, the 48-volt vehicle electrical system can be deactivated in new models introduced from 2023 onwards using the following procedure:

- 1) Switch off the ignition
- 2) Disconnecting 12-volt vehicle battery
- 3) Wait 10 seconds

#### Disconnecting the 48-volt vehicle electrical system in an Audi A5 (2024)

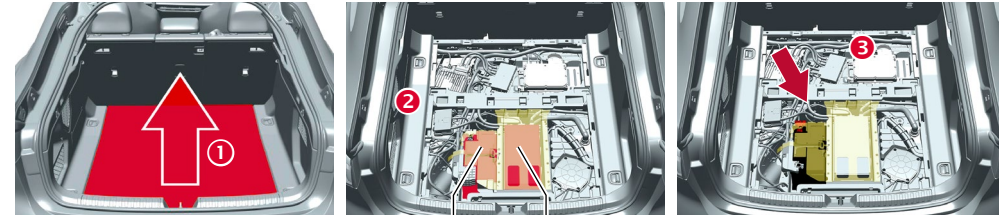

- 1 Lift luggage compartment floor

12-volt battery 48-volt battery

- 2 Locate the batteries

- 3 Disconnect the negative terminal on the 12-volt battery and wait for 10 seconds

**The vehicles with 48-volt technology do not differ externally from the 12-volt variants of the respective model.**

**The installation position and procedure for disconnecting the 48-V battery are described in the rescue cards.**

**In Audi models, the 48-volt battery is usually installed in the luggage compartment. In the Audi A3 from 2020, the 48-volt vehicle battery is located in the passenger compartment under the right-hand front seat.**



## Safety equipment in natural gas vehicles

A number of points distinguish vehicles with a natural gas drive from petrol or diesel vehicles.

It is important for emergency services to know these differences. In Audi natural gas vehicles, the combustion engine can be operated with natural gas or with petrol.

In Audi g-tron models, the natural gas tanks are installed on the underside of the vehicle rear and are partly covered by panelling.

### Fuel tank shut-off valve

The fuel tank shut-off valve is an electromagnetic valve and is opened by the engine control unit during natural gas operation. The valve closes when the engine is at a standstill, in petrol mode, in the event of a loss of power supply and in the event of a crash in which belt tensioners and/or airbags are triggered.

Along with the electromagnetic shut-off valves, the cylinder valves have an integrated thermal fuse and a flow rate limiter that prevents the uncontrolled escape of gas if any damage to the pipes occurs. A non-return valve is also installed in the filler line to the gas tanks. This prevents gas from flowing back out of the cylinder and into the filler line.

### Manual shut-off valve

The manual shut-off valve allows you to close the natural gas tank manually using a conventional tool to make it gas-tight.

The connection to the drainage channel for the thermal release is also open when the shut-off valve is closed for safety reasons.

The electro-magnetic fuel tank shut-off valves automatically interrupt the gas supply when the engine is not running, in petrol mode as well as in the event of a crash.

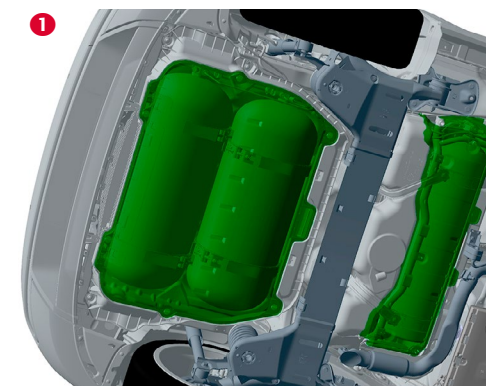

- 1 Remove the tank covers on the underbody. The tank covers are marked in green in this illustration.

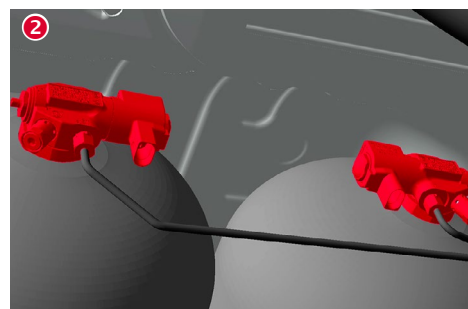

- 2 Locate the gas tank shut-off valves and



- 3 Turn the shut-off valve clockwise as far as it will go using a 5 mm open-end spanner or pliers or a special tool.

The procedure required for manual shut-off of the gas tanks is described in the Audi rescue cards.

### 3. Disable direct hazards / safety regulations

CNG

Labelling of the CNG gas tanks on the rescue cards.



Labelling of the CNG shut-off valves on the rescue cards.



# 4. Access to the occupants

### General instructions

#### Keep your distance

The deployment areas of non-triggered safety systems should be kept clear. This applies in particular when heavy rescue equipment is used or cable connections are cut. During this time, there should be no bodies or tools in the deployment area of the airbags.

If medically justifiable, the patient should also be removed from the deployment area. Fastened seat belts should be cut through or disconnected in view of belt tensioners that have not been triggered. If there are roll bars that have not been deployed, their deployment range should also be kept clear.

#### Investigate the interior

To determine the status of the safety systems, the vehicle interior must be investigated at the start of rescue operations.

All airbag modules are labelled "AIRBAG". The label is usually located on or near the airbag module.

The side airbags installed in the backrests can also be identified by means of a flag sewn into the backrest cover. In the case of curtain airbags, several markings are often found in the upper area of the vehicle pillars or along the roof side member.

Any belt tensioners are not marked. The protective bar is only used on convertible models and is installed behind the rear head restraints. The protective bar cover is labelled "do not cover".

**The maximum possible equipment scope of airbags, belt tensioners and, if applicable, roll-over protection systems can be found in the rescue cards.**

**Markings for side airbags may be covered by the seat belt or protective covers!**

**The installation locations of the belt tensioners and the protective bar can be found in the rescue cards.**

#### Warn the emergency services

All emergency services deployed to deal with the accident vehicle should be informed immediately about the type and status of the safety systems found immediately after the investigation.

This is the only way to ensure that all necessary safety rules are observed during the rescue operation.

#### Battery management

The majority of Audi vehicles are equipped with electrical ignition systems for the airbag and also for the belt tensioners. The airbags cannot be electrically activated by the control unit for safety systems if the power supply is interrupted. The accident vehicle should therefore be de-energised in order to deactivate the safety systems.

The procedure for switching off the engine or drive system and deactivating/disconnecting the batteries is described in chapters 2 and 3.

**The location of the batteries can be found in the rescue cards.**

## 4. Access to the occupants

**After disconnecting the 12-volt battery, all electrical functions (lights, hazard warning lights, electric seat/steering column adjustment etc.) are inoperative. Before disconnecting, ensure that these functions are no longer required.**

### A Removing the interior trim

Irrespective of their design, non-triggered gas generators for airbags and non-triggered belt tensioners should not be damaged.

This is particularly important when removing the roof, especially when separating the vehicle pillars or when cutting through the B-pillar in the lower area.

To ensure that the belt tensioners and gas generators are not damaged, the following options are recommended:

- Removing the interior trim:  
Before cutting through vehicle pillars, the interior trim should be removed in the planned cutting area. Any gas generators or belt tensioners are then visible and a cutting path that avoids damage can be selected. Gas generators for curtain airbags are arranged in a mirror-inverted manner in Audi vehicles. If the installation location is known on one side of the vehicle, the gas generator is located in the same position on the other side of the vehicle.
- Checking the installation position using the rescue cards:  
The rescue cards show, among other things, the installation position of gas generators and belt tensioners. The use of the rescue equipment can be planned to prevent damage to these components.

### Danger posed by airbag components

#### Triggered airbags, belt tensioners and protective bar

If a deployed airbag is in the way, it can be pushed away or cut off if necessary. The dust that escapes when the airbag is deployed and when the air-

bag is compressed can cause slight irritation of the mucous membranes and skin. The vehicle interior should be ventilated if possible. Wearing protective gloves/eye protection is recommended. Unprotected areas of skin should be washed with water as a precautionary measure after the rescue operation. As the area of the gas generator may still be hot for some time, do not lean on a deployed airbag module.

#### Airbags, belt tensioners and protective bars that have not been deployed

Do not damage the gas generators of airbags that have not been triggered! Do not cut into airbag modules!

- Avoid damaging the control unit for safety systems during rescue operations! The location of the control unit can be found in the rescue cards. The control unit is usually located on the centre tunnel in the area of the gear lever.
- Do not place any objects on non-triggered airbag modules and non-triggered protective bars!
- Avoid allowing any heat to be applied to airbag modules, e.g. by using flame-cutting machines. The gas generator in the airbag has a self-ignition temperature of approx. 200°C. For this reason, the airbags in burning vehicles will deploy after prolonged exposure to heat.
- If possible, do not damage belt tensioners that have not been triggered!
- Caution when tilting or raising the vehicle with the ignition switched on and the battery connected! This may cause a protective bar that has not been triggered to activate.

**Chapter 9. Important additional information** “Important additional information” describes which safety systems (airbags, belt tensioners, protective bar, active pedestrian protection system) are installed in current vehicles.

## 4. Access to the occupants

Access to the occupants plays a central role in rescue activities following an accident.

Depending on the accident situation, the emergency and recovery forces have various redundant access options to the occupants.

### Unlocking the vehicle doors

Locked doors can be unlocked normally as follows:

- Remote control buttons
- Button in the door trim
- Manual vehicle key/optional Keyless
- Optionally via app/Keyless Card



Buttons on the vehicle key's remote control



Button in the door trim

**Vehicle or equipment-specific information can be found in the vehicle wallet literature or the vehicle-specific rescue cards.**

**After an accident with airbag triggering, the vehicle doors and boot lid are automatically unlocked. The doors can be opened by firmly pulling on the exterior door handle.**

### Electrically assisted door handles

On some Audi models (e.g. Audi A8), operation of the door handles on the inside and outside is electrically assisted. The doors can be conveniently unlocked with very little effort.

**In the event of an accident in which airbags are triggered, all doors and lids are automatically unlocked.**

**After serious accidents, it may also be necessary to use tools to open the doors.**

**When possible, the electric convenience systems should be used for the rescue prior to disconnection of the battery.**

On vehicles equipped with an electric door lock, shorter operating distances are required to operate the door handles (outside) and door openers (inside). The door lock is designed in two stages. For standard operation, it is sufficient to pull the handle or lever to stage 1 (see figure). For manual opening, pulling up to stage 2 (see figure) is necessary.

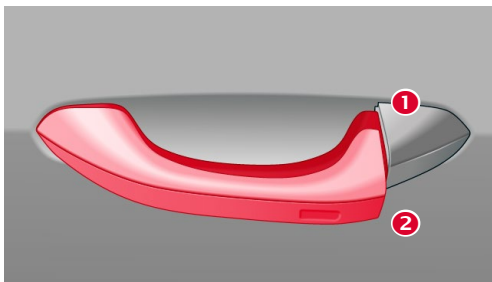

**1 Convenience opening: lift the door handle slightly and open the door.**

**2 Manual opening: pull door handle far outwards with greater force and open the door.**

**When the childproof lock is activated, opening the doors of the 2nd seat row not possible from the inside. To open the door from the inside, the childproof lock must first be deactivated mechanically or electrically.**

**After accidents with triggered airbags, the windows move to a crash position (gap of approx. 5 cm). If necessary, the window can be broken out outwards by gripping it inside.**

## Door handles with sensor surface

Audi models from 2024 (e.g. A5/A6) are equipped with sensor door handles. Reach into the door handle to open the doors.

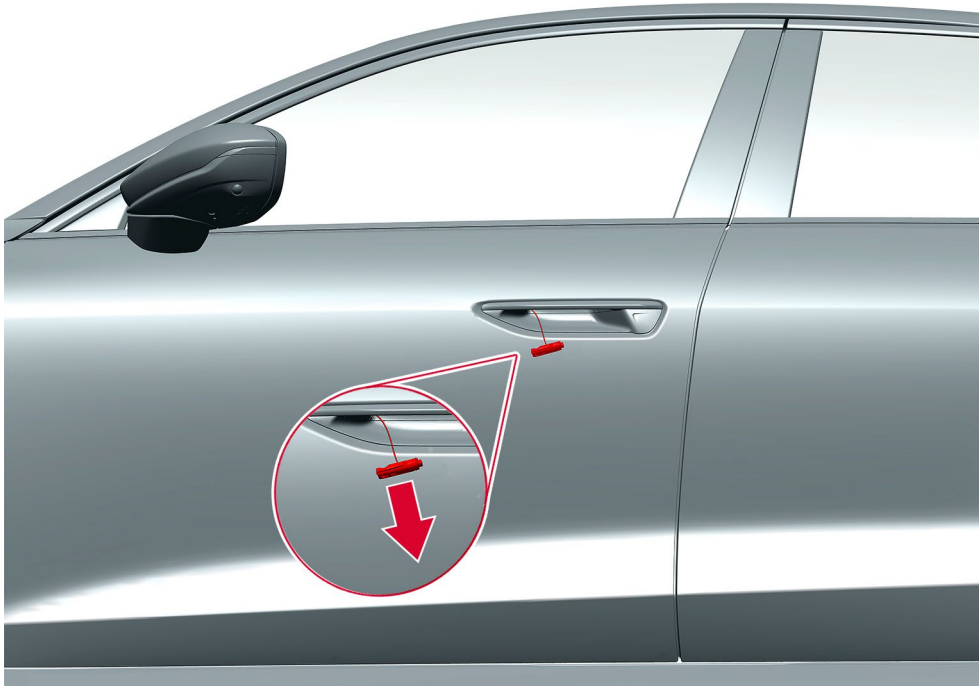

Pull the ejected door pin and open the door

**In the event of accidents with airbag triggering, all doors are unlocked and can only be opened mechanically.  
To do this, pull on the ejected pin at the end of the rope!**

## 4. Access to the occupants

### Access via the boot lid

Depending on the equipment variant, the boot lid can be unlocked as follows:



Button on the boot lid



Button on the remote control



Button in the door trim on the driver side

The boot lid is opened by pressing the electric button in the boot lid in unlocked state. On some models, the boot lid can also be opened using a button in the door trim on the driver's side.

**In the event of an accident in which airbags are triggered, all doors and lids are automatically unlocked.**

**If the 12-volt supply is interrupted, it is not possible to open the boot lid in spite of unlocking.**

**If necessary, the boot lid can be opened manually from the inside. Please observe the notes in the vehicle-specific Owner's Manual.**

### Body reinforcements

A high level of safety for the vehicle occupants is achieved in particular by a rigidly designed passenger cell.

Extra-high-strength and hot-formed steels, thicker walls and a multi-shell structure are used in vehicle body construction. These are the primary areas to avoid when rescuing occupants involved in an accident from current vehicles, but if they must be opened, this requires sufficiently powerful cutting equipment.

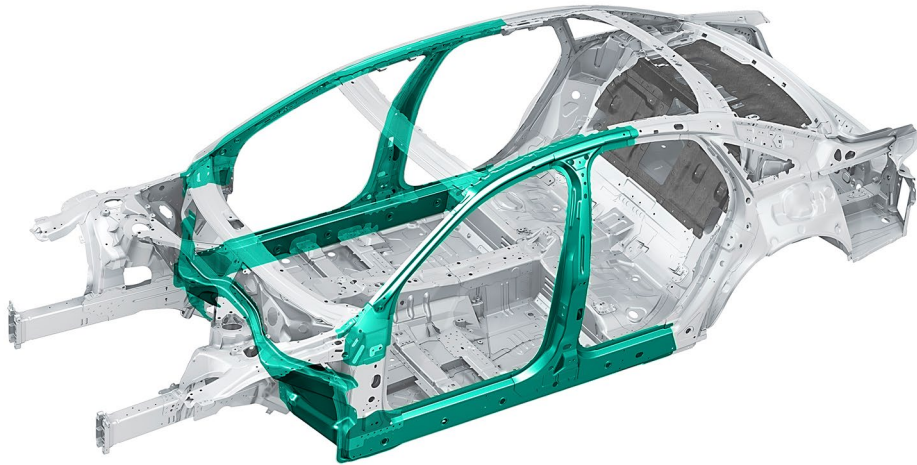

Body with reinforced passenger compartment

Information on the position of reinforcements can be found in the rescue cards for the specific vehicle.



High strength zones

### The side members

In modern vehicles, special steels are used to reinforce the side members. These increase safety in the event of side collisions, especially if the vehicle hits a pole.



Hot-formed steel can only be cut through using high-power cutting tools.



## 4. Access to the occupants

### The A-pillar

Convertibles in particular have an additionally reinforced body in order to achieve the necessary rigidity even without a roof. Reinforcing tubes may be fitted at various positions in the vehicle including the A-pillar in order, together with the roll bars, to optimise the protected area if the vehicle overturns.

It may also be possible to open the convertible roof (which is usually a fabric roof) by conventional means or by pushing up the roof with a ram.

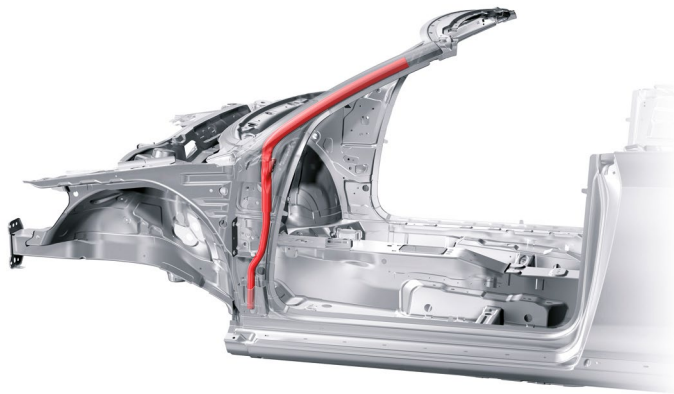

A-pillar reinforcement in cabriolets



**Cutting through the A-pillar near the A-pillar reinforcement is only possible using powerful rescue equipment.**

**The position of special reinforcements in individual vehicles can be found in their rescue cards.**

### The B-pillar

The B-pillar is reinforced using extra-high-strength and hot-formed sheet metal and a multi-shell structure. In addition, modern B-pillars have a larger cross-section.

The B-pillar is additionally reinforced in the area around the belt guide by the belt height adjuster, which makes it more difficult to cut through. These areas should therefore be deliberately avoided.



B-pillar with multi-shell structure

**The easiest point to cut through vehicle pillars is the area above the belt height adjuster.**

**The pillar can also be cut through in the lower area. However, note that the cross-section of the pillar is very large and that the belt tensioner is usually located there.**

## 4. Access to the occupants

### Side impact protection

Side impact protection is installed in the doors. The tubes or sections are arranged horizontally or diagonally behind the outer door panels.

The high-strength sections can be cut through with powerful cutting equipment.

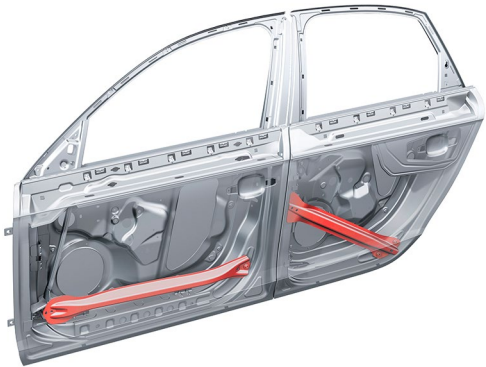

Side impact protection in the doors

**The position of special reinforcements in individual vehicles can be found in their rescue cards.**

# Glazing

The windows in Audi vehicles are made of toughened or laminated safety glass. The windscreen is always made of laminated safety glass and the side windows, rear windows and panoramic roof are made of tempered safety glass. The side and rear windows may also be made of laminated safety glass.

## Tempered safety glass

Tempered safety glass is thermally tempered glass that can withstand high loads. When broken it crumbles into small granular pieces. Tempered safety glass is used for side windows, rear windows, sliding sunroofs and the panoramic glass roof.

**Intact windows can burst suddenly during rescue work at the vehicle. Depending on the accident situation and the scope of emergency work, the windows should be removed first. Windows can be removed by concentrated impact using an automatic punch or an emergency hammer, for example. The windows should first be secured.**

## Laminated safety glass

Laminated safety glass consists of two panes of glass with a layer of film in between. The glass remains largely intact when damaged. It is used for windcreens and sometimes for side windows. The windcreens are bonded to the body with adhesive.

**Because laminated windows cannot suddenly burst, they only have to be removed if it is necessary for the rescue work. These windows can be removed using special glass saws or metal cutting claws.**



Tempered safety glass

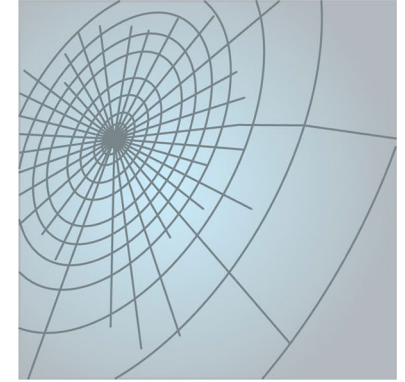

Laminated safety glass



**Protect the occupants from shards of glass before removing the panes of glass.**

**Information about the window versions installed is also described in the respective rescue cards for more recent models.**

## Driver seat and steering wheel adjustment mechanisms

The seat systems and steering columns in Audi vehicle models may be operated mechanically or electrically.

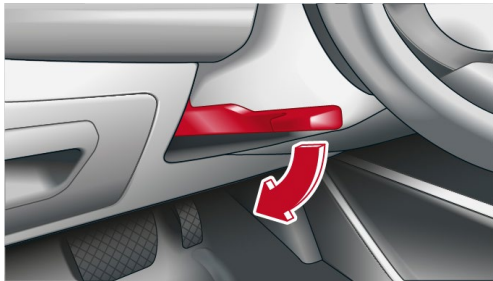

Manual steering wheel position adjustment



Electric steering wheel position adjustment

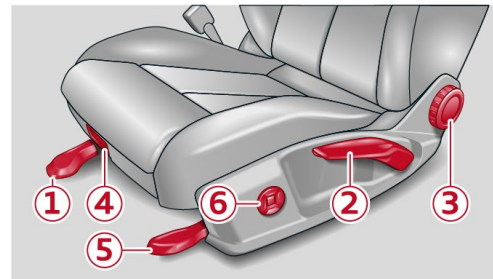

1 Longitudinal adjustment  
2 Height adjustment  
3 Backrest adjustment  
4 Seat depth adjustment  
5 Seat cushion angle adjustment  
6 Lumbar support adjustment

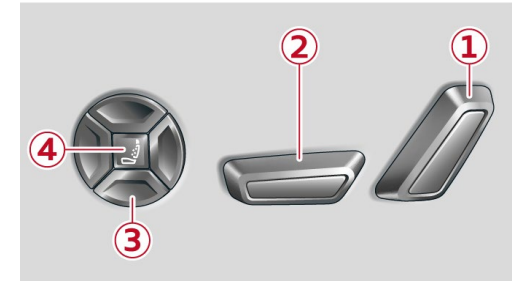

1 Backrest adjustment  
2 Longitudinal and height adjustment  
3 Lumbar support adjustment  
4 Massage function adjustment

### Electric convenience systems

Depending on the model series and vehicle equipment, Audi vehicles feature a range of electrically operated convenience systems, for example:

- Electric doors
- Electric windows
- Electric sliding sunroof
- Electric seat adjustment
- Electric steering column adjustment
- Electric unlocking, opening and closing of the luggage compartment

If the battery or batteries are disconnected, these systems can no longer be operated.

**In the event of an accident in which airbags are triggered, electrically operated doors and lids are unlocked automatically.**

**When possible, the electric convenience systems should be used for the rescue prior to disconnection of the battery.**













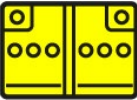

















**The battery should only be reconnected to the vehicle electrical system by workshop personnel.**

# **5. Stored energy / liquids / gases / solids**

## 5. Stored energy / liquids / gases / solids

Audi models carry a wide range of service fluids. Only if you recognise a hazard during an emergency can you react appropriately and take suitable action to prevent it.

Example list of possible stored forms of energy/  
liquids/gases/solids:



In the event of mechanical deformation of the battery system, there is a risk of a thermal reaction in the high voltage battery. Monitor the temperature of the high voltage battery!

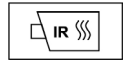

With all energy carried or stored (pyrotechnical belt tensioners, airbags, gas struts, fuels, gases, etc.) there is a risk of expansive discharge after an accident.



Always wear appropriate protective equipment when handling leaking operating fluids.



## Vehicles with a high-voltage system

In vehicle technology, the following voltage levels are referred to as “high voltage”:

- greater than 60 volts with direct current (DC)
- greater than 30 volts with alternating current (AC)

### High-voltage components

In addition to the high-voltage battery, the electric drive motors, the external charging connection and the high-voltage distributor/control unit, the so-called power electronics, various ancillaries, such as a high-voltage air conditioner compressor and supplementary heater, are operated with a high voltage and connected to each other by high-voltage lines. All high-voltage lines and high-voltage connectors are provided with orange insulation in their visible areas.

The listed components may also be present in a vehicle multiple times. All other electrical components, such as lighting, on-board electronics etc., are supplied via the 12-volt electrical system.

Illustration of a high-voltage system:

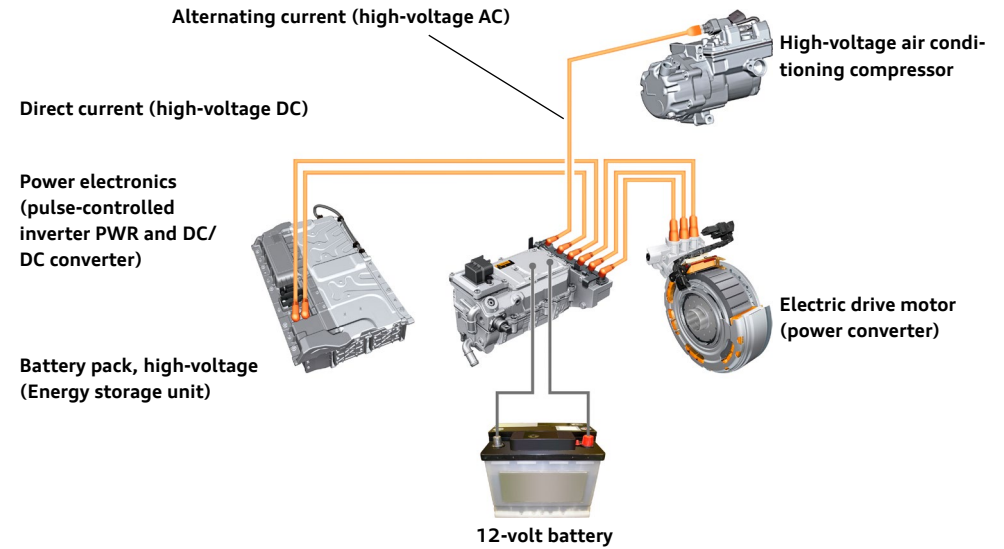

**The installation positions of the high-voltage components and the routing of the high-voltage lines are shown in the rescue card.**



### High-voltage safety concept

The electrical components in the vehicle, such as the power electronics, the electric drive motor, the high-voltage battery and ancillaries such as an electrical air conditioner compressor, operate in voltage ranges above 60 volts of direct current (DC). These are connected to high-voltage lines whose insulation is marked with the warning colour orange, as the hazard potential is higher than in conventional vehicles.

Likewise, all lines with an alternating voltage greater than 30 volts can be identified by the warning colour orange. If an insulation fault occurs, e.g. due to external damage, this is detected by the system. The response ranges from the mere indication of an insulation fault through to the shut-off of the entire high-voltage system.

If handled incorrectly, the high voltage in the high-voltage system poses a potential hazard. The vehicle therefore has a comprehensive safety concept. The following chapter explains the basic principles of the safety concept.

#### Galvanic separation

The high-voltage system is galvanically isolated from the vehicle earth. This means that there is no direct electrical connection between the active parts of the high-voltage system and the vehicle body.

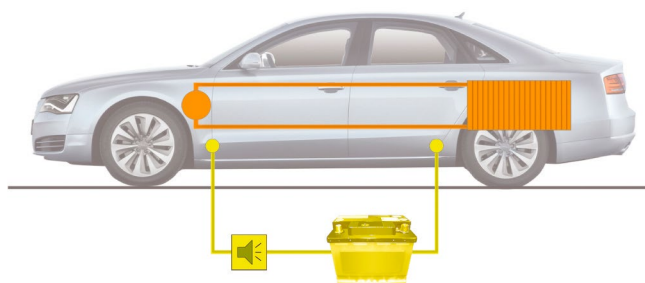

#### Accidental contact protection cover

The entire high-voltage system is insulated from the 12-volt network and body and is designed to be touch-proof.

#### Potential equalisation

The metal housings of all high-voltage components are connected to the body so that they can conduct electricity. This ensures that no dangerous contact voltage can occur on the metal housing even in the event of a fault.

#### High-voltage lines

All high-voltage lines are fitted with orange-coloured insulation. Their orange sheathing conveys a clear visual signal. The high-voltage lines are partly protected against damage by additional covers and hoses.

#### Short circuit detection

In the event of a short circuit or overcurrent, the overcurrent protection device (fuse) trips and interrupts the current flow.

#### Discharge of residual voltage

In the high-voltage system, the discharge circuit ensures that the high-voltage system is generally de-energised after approx. 20 seconds in the event of an accident in which belt tensioners and/or airbags are triggered or an unforeseen malfunction.

In all other cases, the high-voltage system can be deactivated by actuating an emergency cut-out connection. Here too, the high-voltage system is de-energised approx. 20 seconds after actuation of the emergency cut-out connection.

#### Insulation resistance monitoring

For insulation resistance monitoring, i.e. monitoring whether the high-voltage system is disconnected from the body, the insulation resistance of the high-voltage system is checked periodically.

Malfunctions are indicated to the driver by means of a warning message, a yellow or red lamp and an acoustic signal in the instrument cluster.

## 5. Stored energy / liquids / gases / solids

### Switch off in case of crash

There is a load-breaking relay with a protective shut-off function on both battery terminals, which is closed during operation of the high-voltage system. In the event of an accident in which belt tensioners and/or airbags are triggered, the high-voltage battery receives a crash signal to open the load-breaking relays. The load-breaking relays of the high-voltage battery open and the high-voltage system outside the battery is discharged. The high-voltage connections for the high-voltage battery and all high-voltage components are then de-energised. In some vehicles, once the crash signal has been received, shut-off is performed by a pyrotechnical fuse, in which the battery voltage of the high-voltage battery is interrupted.

In addition to the automatic crash shut-off, the vehicle-specific rescue cards for hybrid vehicles and electric vehicles contain information on how the high-voltage system and the vehicle can be deactivated.

**The high-voltage system is de-energised approx. 20 seconds after shut-off/deactivation.**



**Improper handling of high-voltage components and high-voltage lines can prove fatal due to high voltage and the associated potential flow of current through the human body.**



**Even after disabling the high-voltage system, there is still voltage in the high-voltage battery. The high-voltage battery must not be damaged or opened. There is danger of death!**



**When working with hydraulic rescue equipment, when lifting, securing, towing or pulling the vehicle, the position of the high-voltage components and high-voltage lines must be taken into account (see vehicle-specific rescue card).**



**Do not touch, cut or open damaged high-voltage components and/or high-voltage lines! Wear appropriate personal protective equipment! Cover damaged components with suitable equipment such as insulating blankets!**

## Warning labels for high-voltage components

All high-voltage components are labelled with clear warning stickers. An exception to this are the high-voltage lines, which are immediately recognisable by the orange warning colour of their sheathing.

Two types of warning sticker are used:

- Yellow stickers with a warning symbol for electrical voltage
- Stickers with the word “Danger” on a red background

The yellow stickers refer to the high-voltage components that are installed near the sticker or concealed under covers.

The warning stickers with the “Danger” lettering indicate the high-voltage components directly.



Examples of warning stickers in high-voltage vehicles:





## The high-voltage battery

High-voltage batteries are rechargeable batteries. Various types of battery are used, depending on the manufacturer and the vehicle. They differ in the chemical components used in the battery cells for the anode, cathode and electrolyte, as well as in the shape of the cell (round, prismatic, pouch).

The high-voltage batteries at Audi are lithium-ion batteries. Within the vehicles, the high-voltage battery is located in a stable housing in areas that are protected against deformation in most crash cases. The sizes and fitting locations of the high-voltage batteries differ depending on the type of vehicle. An all-electric vehicle requires a larger high-voltage battery than a hybrid vehicle.

In electric vehicles, the high-voltage battery is usually bolted in the centre under the vehicle as a load-bearing body component. In hybrid vehicles, the high-voltage battery is usually located in the rear vehicle compartment (in front of or behind the rear axle).

In both hybrid and electric vehicles, the high-voltage battery consists of battery cells connected in series and connected together to form modules. Several modules are installed together with the peripherals in a metallic housing. The housing is connected to the vehicle via a potential equalisation line.

All high-voltage batteries are installed in a stable housing to protect the battery cells in the event of an accident and to prevent electrolyte from escaping in the event of defective battery cells.

**Depending on the vehicle variant/equipment, the high-voltage battery may consist of several battery packages.**

**In addition to the high-voltage battery, Audi electric vehicles also have at least one 12-volt electrical system battery.**

**Because there are so many different battery types with different chemical components and because battery technology is constantly developing, this guide cannot address the specific behaviour and hazards of each type.**

If the high-voltage battery is damaged or overheated, exothermic chemical reactions can occur (thermal runaway): these reactions lead to rapid heating of the battery cells. This will cause the battery to catch fire and expose it to toxic fumes.

Important information on this can be found in chapter 6. *In case of fire*. Information on how to handle the energy stored in the battery can also be found in chapter 8. *Towing / transportation / storage*.

### Lithium-ion battery separated from the vehicle

If the high-voltage energy storage unit and/or parts thereof are disconnected from the vehicle in the event of an accident, it must be assumed that there is an electrical, chemical, mechanical and thermal hazard presented by the high-voltage energy storage unit.

The following points must be observed:



**In the event of damaged high-voltage energy storage units, high-voltage components or high-voltage lines, e.g. open components or torn off lines, contact with these damaged areas must be avoided as far as possible!**



**When working with hydraulic rescue equipment, when lifting, securing, towing or pulling the vehicle, the position of the high-voltage components and high-voltage lines must be taken into account (see vehicle-specific rescue card)!**



**If work in these areas cannot be avoided, damaged parts or high-voltage energy storage units must be covered so that they are electrically insulated. Here, use of a suitable electrically insulating flexible cover is recommended (undamaged plastic foil or another suitable electrically insulating cover, e.g. in accordance with IEC 61112).**

If a high-voltage energy storage unit has been separated from the vehicle, there may still be other parts of the full energy storage system in or on the vehicle.

Separated components of high-voltage energy storage units must only be lifted from the ground with electrically insulating equipment!



**Leaking electrolytes from damaged high-voltage energy storage units are irritating, flammable and potentially corrosive. Please wear appropriate personal protective equipment!**

**To protect the face, always work with the helmet visor folded down.**

Liquids leaking from high-voltage energy storage units are usually coolants. Electrolytes are only present in small quantities (millilitres) in the individual cells.

## 5. Stored energy / liquids / gases / solids

The following images show some examples of the different installation concepts of the high-voltage battery in Audi vehicles. The exact installation position of the high-voltage battery can be found in the rescue card for the respective model.

### Different installation concepts for the high-voltage battery

High-voltage battery in the vehicle floor with additional package at the rear (Audi e-tron)

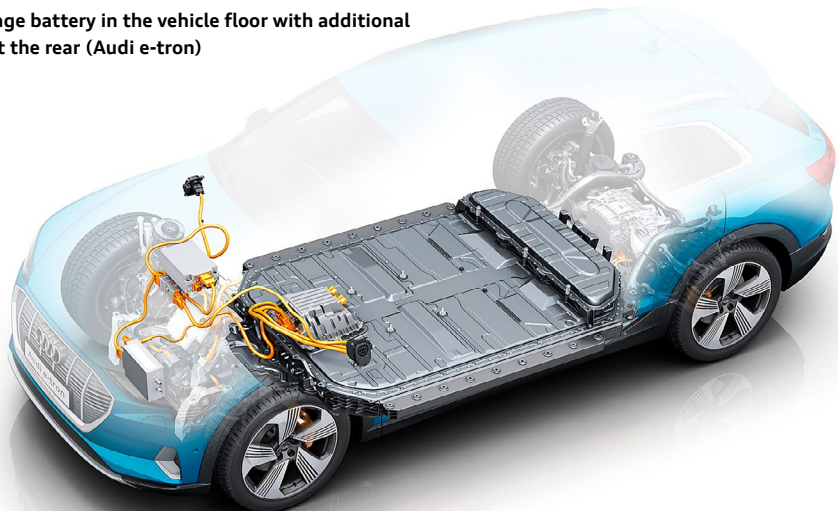

Rescue card for the Audi e-tron

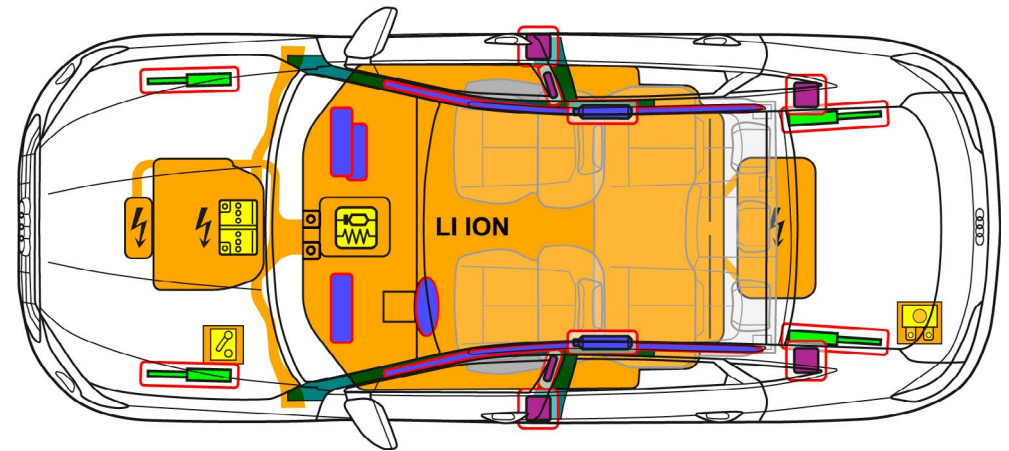

### Different installation concepts for the high-voltage battery

High-voltage battery in the vehicle floor with "foot garage" for the rear passengers (e-tron GT)

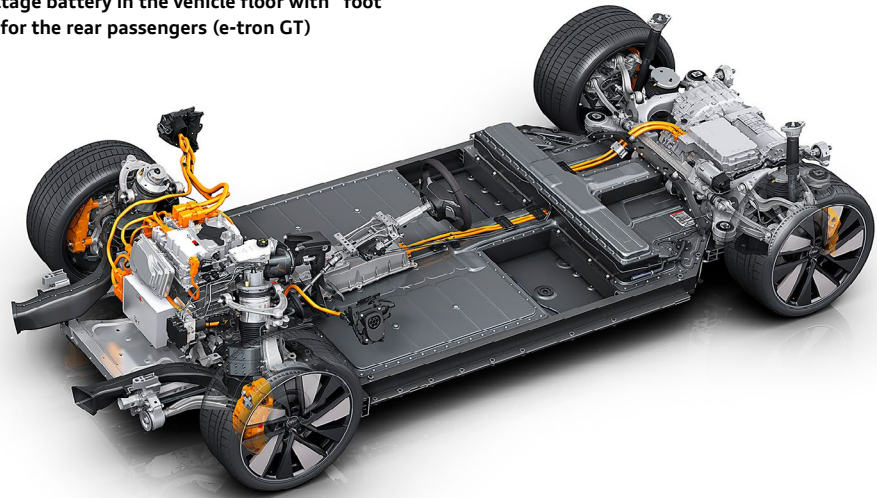

Rescue card for the e-tron GT

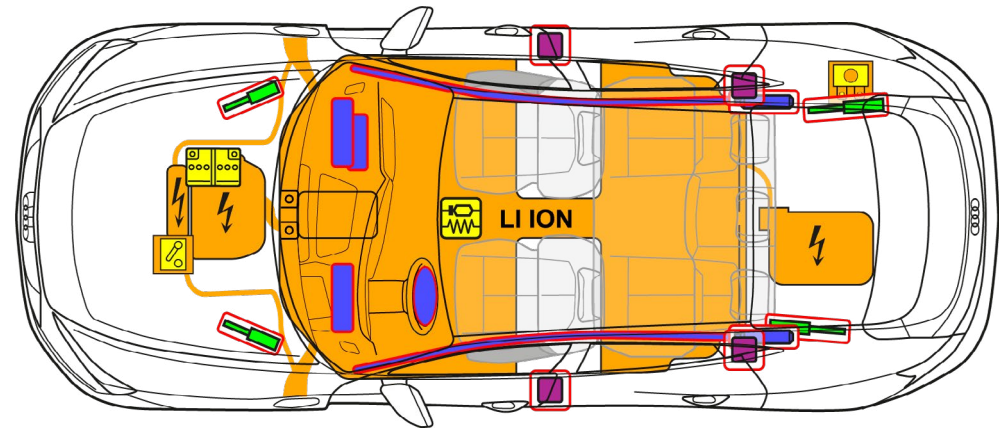

High-voltage battery in the vehicle floor (Audi Q4 e-tron)

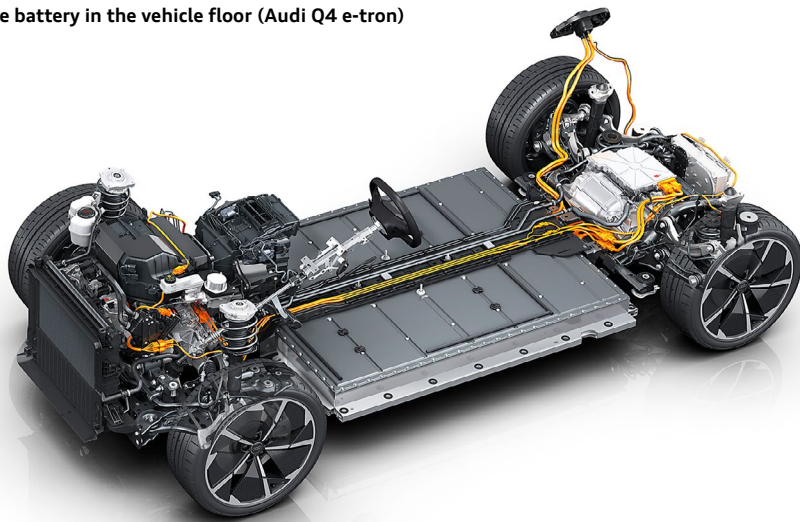

Rescue card for the Audi Q4 e-tron

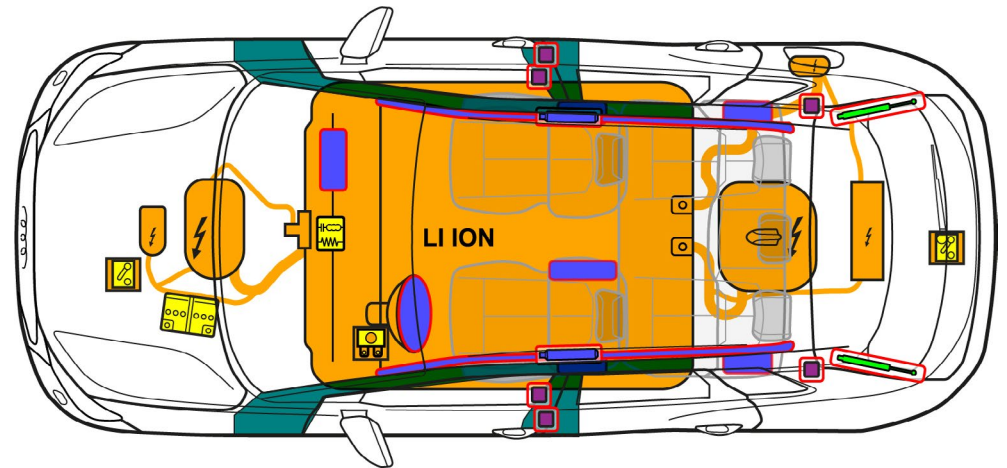

### Different installation concepts for the high-voltage battery

High-voltage battery in the rear of the vehicle (Audi Q8 TFSI e)

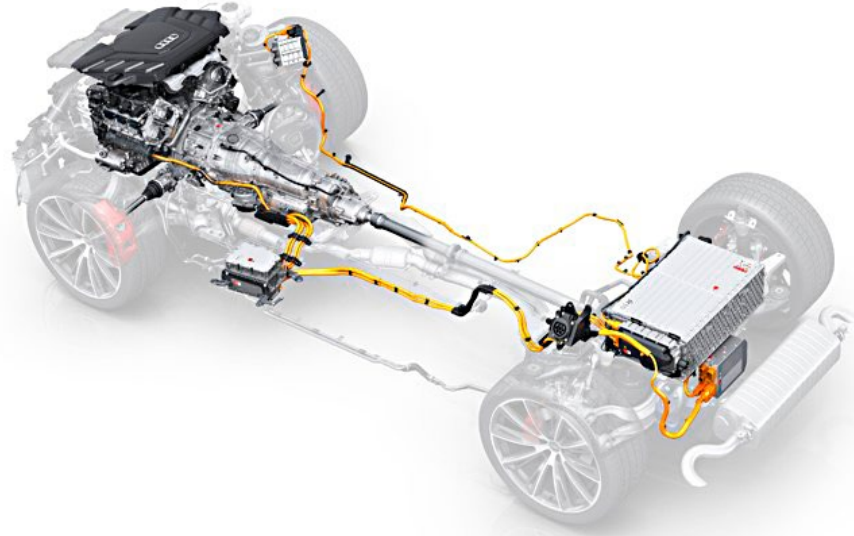

Rescue card for the Audi Q8 TFSI e

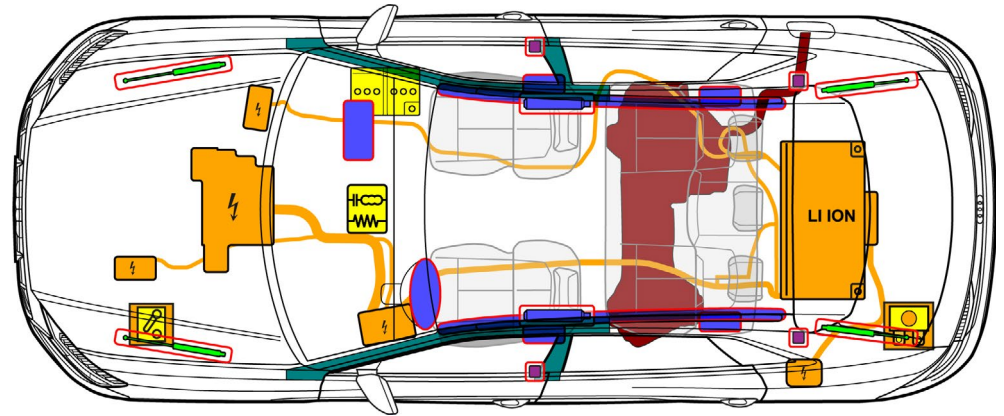

High-voltage battery in front of the rear axle (Audi A3 TFSI e)

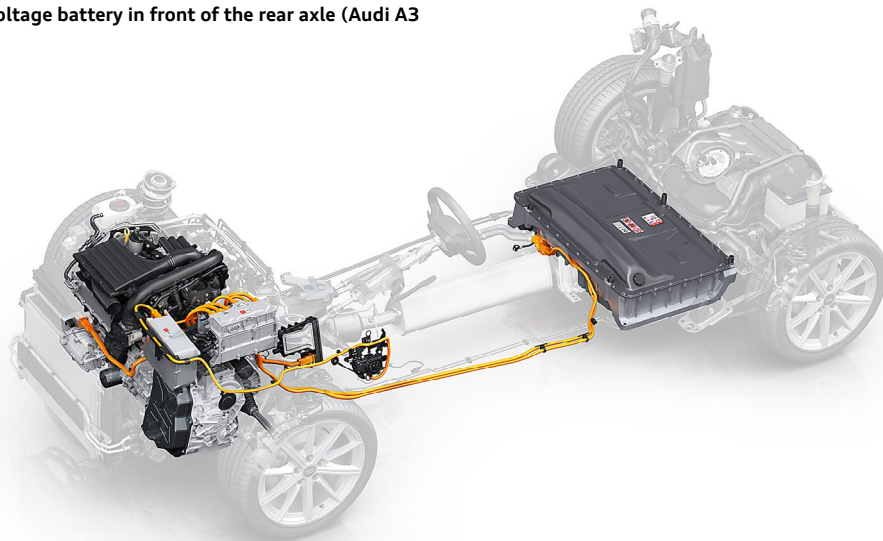

Rescue card for the Audi A3 TFSI e

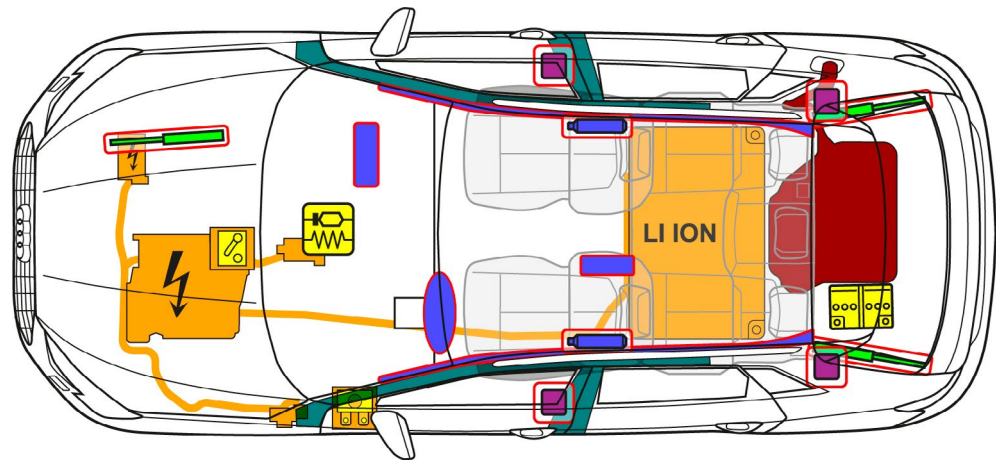



## Hazard warnings



Lithium-ion batteries are installed in Audi models with high-voltage technology.



Contaminated extinguishing water must be dealt with according to the national procedures for emergency and recovery personnel.



If coolant leaks from the battery cooling system, there is a risk of a thermal reaction in the high voltage battery. Lithium-ion batteries can self-ignite or re-ignite after fire-fighting measures.



Monitor the temperature of the high voltage battery!



Avoid skin contact and inhaling electrolyte vapours, as electrolyte is combustible, corrosive and irritating!  
In the event of outgassing of the high voltage battery, toxic vapours may form.  
Please wear appropriate personal protective equipment!

## 5. Stored energy / liquids / gases / solids

### 48-volt battery 12-volt battery <sup>LI ION</sup>

A lithium-ion battery is installed in Audi MHEV models with 48-volt voltage. Lithium-ion batteries with 12-volt voltage are also possible in some models.



Lithium-ion batteries can self-ignite or re-ignite after fire-fighting measures.



Avoid skin contact and inhaling electrolyte vapours, as electrolyte is combustible, corrosive and irritating!  
In the event of outgassing of the high voltage battery, toxic vapours may form.  
Please wear appropriate personal protective equipment!

Vehicle-specific information is also described in the respective rescue cards.

### 12-volt vehicle electrical system battery

The starter batteries in Audi models are generally 12-volt batteries with lead-acid technology.



Leaking electrolyte is highly flammable.



There may be a highly explosive gas mixture in the battery.  
No flames, sparks, open light and smoking near the battery!  
Wear appropriate personal protective equipment!



Escaping electrolyte can cause severe burns to skin.



Warning sticker on 12-volt vehicle battery

Vehicle-specific information is also described in the respective rescue cards.

Further information is available from the Battery Section of the German Electrical and Electronic Manufacturers' Association [www.zvei.org/verband/fach-verbaende/batterien](http://www.zvei.org/verband/fach-verbaende/batterien).

## Flammable materials

Examples of these include:

- Plastics
- Electrolytes
- Resins
- Magnesium
- Gases or other flammable liquids

Resins are used for bonding carbon fibres, magnesium components are found in the engine compartment.



**Avoid skin contact and inhaling electrolyte vapours, as electrolyte is combustible, corrosive and irritating.  
Please wear appropriate personal protective equipment!**



## Natural gas vehicles

The natural gas tanks in the Audi g-tron models are installed in the rear area on the underside of the vehicle. In the new Audi models A3 g-tron, A4 g-tron and A5 g-tron, an additional natural gas tank is installed in the area of the rear axle and fuel tank. The A4 g-tron and A5 g-tron models also have a fourth natural gas tank located at the rear above the subframe of the rear axle. The natural gas tanks are fastened using tensioning straps to a carrier that is bolted to the body.

The natural gas tanks in the A4 g-tron and A4 Avant g-tron consist of a plastic material mix with a layered structure. In the A3 g-tron, the two natural gas tanks installed behind the rear axle are also made of a plastic material mix, while the natural gas tank in front of the rear axle is made of steel.

### Physical properties of natural gas

- Natural gas is a colourless, odourless, combustible gas
- Natural gas is mixed with an odourant, for example, for use in a vehicle. This allows any escape of natural gas to be determined before the lower explosion limit is reached.
- Natural gas is lighter than air (density ratio natural gas/air approx. 0.6) and therefore dissipates quickly outdoors!
- Explosion range between 4% by volume and 17% by volume
- Ignition temperature approx. 640°C



**Contaminated extinguishing water must be dealt with according to the national procedures for emergency and recovery personnel.**

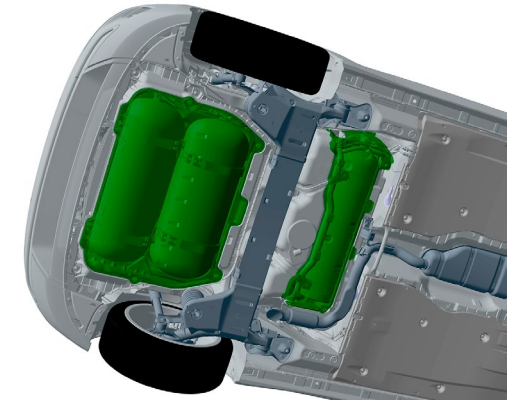

### Safety equipment

The entire natural gas system has been installed in a way that provides the best possible protection from damage and the effects of weather. The gas tanks are highly stable and heat resistant. The high-pressure pipes and connecting elements are made of seamless stainless steel and are routed outside the passenger compartment.

Along with the electromagnetic shut-off valves, the cylinder valves have an integrated thermal fuse and a flow rate limiter that prevents the uncontrolled escape of gas if any damage to the pipes occurs. A non-return valve is also installed in the filler line to the gas tanks. This prevents gas from flowing back out of the cylinder and into the filler line.



**Avoid skin contact and inhalation of broken carbon fibres.**

### Different installation concepts for natural gas tanks

Audi A3 g-tron with 3 gas tanks

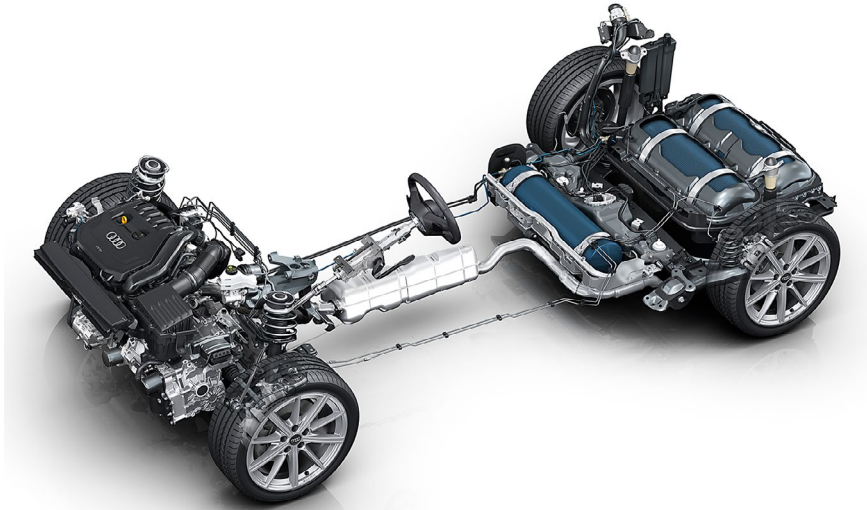

Rescue card for the Audi A3 g-tron (in accordance with ISO 17840)

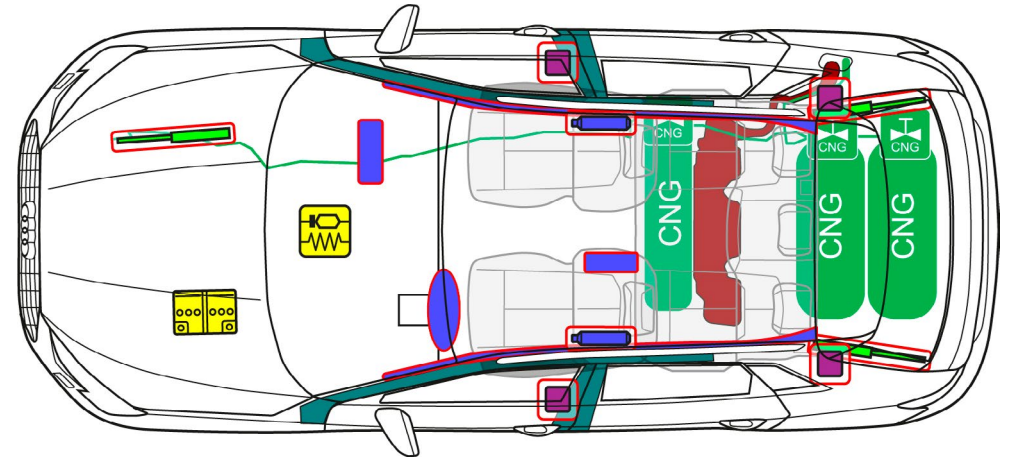

Audi A4 g-tron with 4 gas tanks

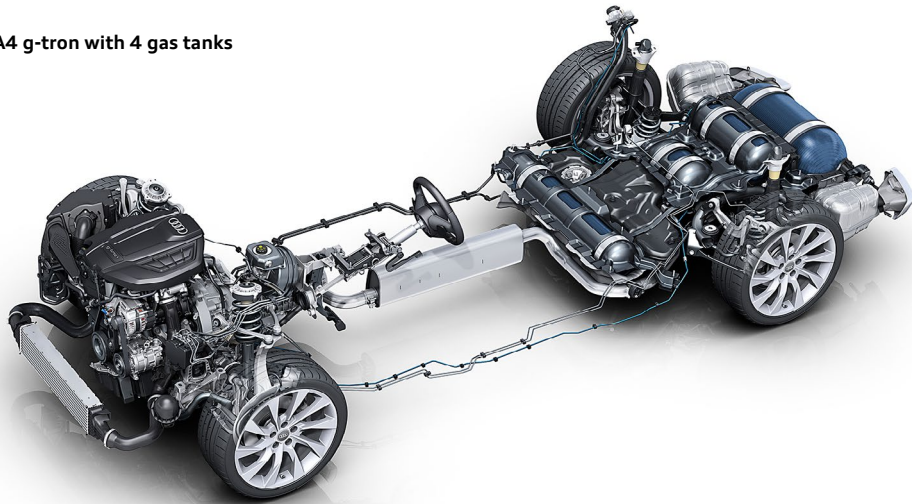

Rescue card for Audi A4 g-tron (does not comply with the current version of ISO 17840)

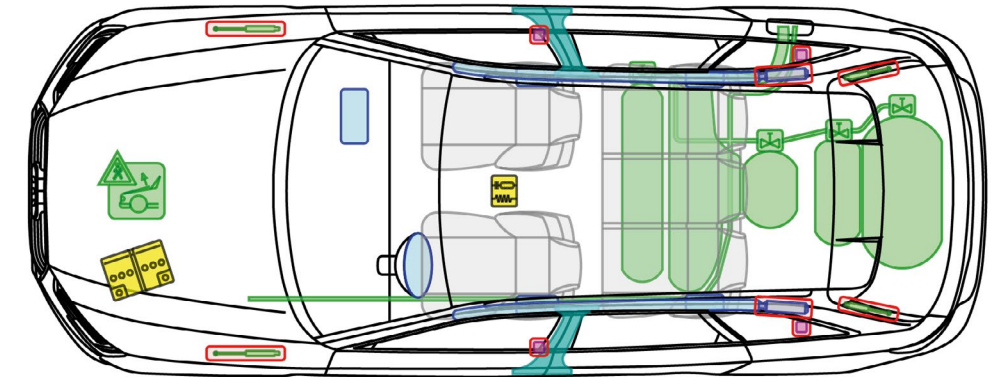



## Air conditioning system

The refrigerants R 134 a, R 1234 yf, R 744 and CO<sub>2</sub> are used for the air conditioning systems. Further information on the various refrigerants can be found on the following page:

[https:// www.dguv.de/ifa/gestis/gestis/stoffdatenbank/index.jsp](https://www.dguv.de/ifa/gestis/gestis/stoffdatenbank/index.jsp)



## Compressed air tanks

Some Audi models have compressed air tanks for air suspension or air conditioning systems, for example. Do not damage these compressed air tanks and never open them by force.



## Flammable materials

Examples of these include:

- Plastics
- Electrolytes
- Resins
- Magnesium
- Gases or other flammable liquids

# 6. In case of fire

## Vehicle fire

In principle, all country-specific regulations, work instructions and guidelines issued by the respective fire-fighter associations and public authorities on how to proceed in the event of a vehicle fire must be observed. When possible, the fire must be prevented from spreading to the energy storage unit (fuel, gas, battery).

All the usual and familiar extinguishing agents such as water, foam, CO<sub>2</sub> or powder can be used.

Which extinguishing agent is to be used with which extinguishing method can only be decided at the deployment site, and is highly dependent on the actual situation and the equipment available.



**If the airbags did not deploy during the accident, they may deploy in the event of a vehicle fire.**





## Fire in high-voltage vehicles

Dealing with high-voltage vehicles is usually no more dangerous than dealing with petrol or diesel vehicles, but a number of points do differ. Knowledge of these differences can be important for rescue operations in the event of accidents involving passenger vehicles.

The following distinction must be made in the event of a vehicle fire with high-voltage vehicles:

- Vehicle fire without the high-voltage battery catching fire:**  
 As is the case for a passenger vehicle with a conventional drive, all conventional and familiar extinguishing agents such as water, foam, CO<sub>2</sub> or powder can be used in case of a “normal” fire in a hybrid or electric vehicle (HEV or BEV, without the high-voltage battery catching fire) depending on requirements and/or availability.
- Vehicle fire with the high voltage battery catching fire:**  
 Smoke, flying sparks, darting flames from the battery may indicate that the lithium-ion battery is involved in the fire.  
 When a high-voltage battery catches fire, it should be extinguished with water whenever possible and then be cooled.  
 In this case, it must be ensured that sufficient water is used and, when possible, the water enters the high-voltage battery through the openings caused by the fire or collision.  
 The jet of water should be aimed as directly as possible at the battery.  
 The installation position of the high-voltage battery can be found in the rescue card for the respective model.

The decision about which measures are suitable is made at the deployment site by the fire brigade, and is highly dependent on the actual situation (e.g. progress of the fire and time at which the fire brigade arrives) and the equipment available.

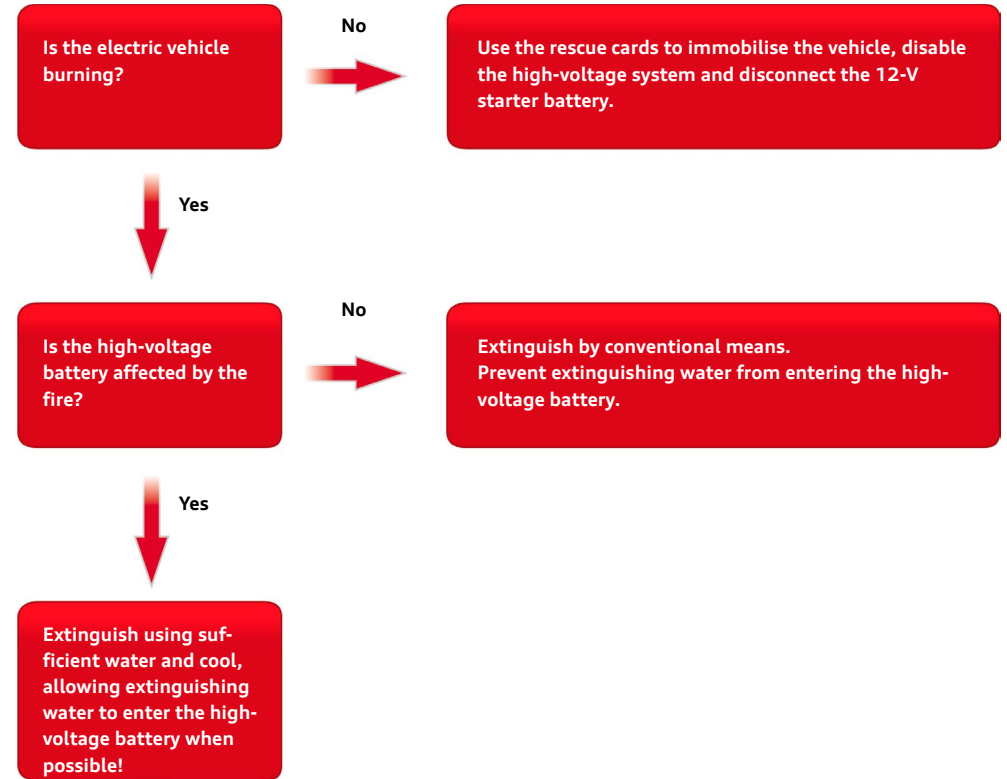

Flow chart for fires in electric vehicles.

	<p><b>Use large amounts of water</b></p>				
	<p><b>Lithium-ion batteries can self-ignite either immediately or after a delay when damage occurs or they are not used properly, or re-ignite after fire-fighting measures. Wear appropriate personal protective equipment!</b></p>				

## 6. In case of fire

If severe damage occurs (e.g. a dented, broken or cracked housing), a lithium-ion battery may react to the effect of water or effect of the fire immediately or only after a delay. This is why signs of a reaction (e.g. smoke, heat, noises, sparks etc.) must be observed during activities on a vehicle with a lithium-ion battery which has been in an accident.

In the event of a reaction by the lithium-ion battery, protective measures and countermeasures must be initiated.

Smoke hazardous to the human health is produced from fires in electric or hybrid vehicles, just as it is in vehicles with a conventional drive. This is why the corresponding personal protective equipment is recommended.

In the event of a fire, outgassing of the high-voltage battery should be expected, as the battery features mechanical safety mechanisms that open, for example in the event of an increase in temperature or pressure due to a fire, and therefore result in deliberate “outgassing” and pressure release.

Extinguishing a vehicle with a high-voltage battery and extinguishing a burning high-voltage battery is possible. According to the VDA guide on rescue and recovery in accidents, water is the most suitable extinguishing agent and there is no fundamental difference from fighting a fire in a conventionally powered vehicle.

If the high-voltage battery is involved in a fire, large quantities of water are required to cool or extinguish an undamaged high-voltage battery that is reacting.

Following a reaction, the lithium-ion battery must be cooled with water until it has reached a temperature approximately equivalent to ambient temperature. The use of a thermal imaging camera or an IR thermometer is recommended.



**After putting out the fire, there may still be dangerous voltages.**



**When batteries are not completely burnt out, they may ignite again. Extinguished vehicles must be moved to a safe position; the vehicle may have to be watched.**



**A sufficient safety distance must be maintained. The corresponding self-contained respiratory protection equipment must be worn!**

**Evaporation and gases can be suppressed by spraying jets of water.**

**Defective cells may burst, causing an exothermic reaction.**

**A fire may break out some time after the accident, as there may be a residual risk of delayed fire. This is particularly the case if the high-voltage energy storage unit is damaged (see also section 8 “Towing / transportation / storage”). An electrical hazard may also persist. High-voltage components must not be touched and suitable personal protective equipment must be worn. High-voltage cables may have been damaged by the heat.**

**More information can be found on the respective rescue cards.**



### Fire in gas vehicles

Dealing with natural gas vehicles usually is no more dangerous than dealing with petrol or diesel vehicles; however, there are also a number of special features in this case that must be observed during rescue operations in the event of accidents involving passenger vehicles.

In the event of a vehicle fire in which the natural gas fuel tanks are also exposed to heat, the thermal fuses will react at a temperature of approx. 110°C and a defined discharge of the natural gas occurs, which ignites and burns off. When the natural gas fuel tank is full, blowing off the natural gas takes approx. 90 seconds until it is completely empty.

Vehicles may be equipped with one or more gas tanks. The time at which a specific tank blows off/burns off cannot be determined precisely. As soon as no more natural gas is being blown off, conventional fire fighting can begin. If the natural gas tanks are not affected by the fire (e.g. in the event of a fire in the engine compartment), fire fighting can also be initiated straight away.



**When the overpressure protection reacts, gas escapes from the valve. If the vehicle is standing on its wheels, the flow of gas is directed downwards towards the ground. If the vehicle is lying on its side or on its roof, a darting flame may emerge to the side or upwards. Maintain a safe distance from the vehicle! Approach it from the front whenever possible!**



**Personal protective equipment must be worn, including self-contained breathing apparatus!**



**If the airbags did not deploy during the accident, they may deploy in the event of a vehicle fire.**



**A sufficient safety distance must be maintained. Corresponding personal protective equipment must be worn!**

**More information can be found on the respective rescue cards.**

# 7. In case of sub- mersion

### Vehicle under water

A vehicle that is immersed in water must be dealt with in the same way as a damaged vehicle that has been in an accident.

The safety and security regulations must be observed, and the procedure to eliminate immediate dangers must be followed, see chapter 3. *Disable direct hazards / safety regulations.*



### High-voltage vehicle under water

- When it is in the water, the high-voltage system does not present an increased risk of electric shock.
- The same instructions apply as in chapter 3. *Disable direct hazards / safety regulations.*
- The recovery procedure is the same as for conventional vehicles. This also applies to bodies made of carbon fibre reinforced polymers.

Source: Verband der Automobilindustrie (VDA), Unfallhilfe & Bergen bei Fahrzeugen mit Hochvolt-Systemen, FAQ.



### Natural gas vehicle under water

- The same instructions apply as described in chapter 3. *Disable direct hazards / safety regulations.*
- The recovery procedure is the same as for conventional vehicles.

After recovering the vehicle, allow the water to drain.

**If gas escapes, close the shut-off valves of the tanks (see chapter 3. *Disable direct hazards / safety regulations*).**



**In the event that water enters the high-voltage battery, electrolysis may be triggered and cause a deflagration of oxyhydrogen gas.**

**The high-voltage system must be deactivated (see chapter 3. *Disable direct hazards / safety regulations*).**

**Wear appropriate personal protective equipment!**

# **8. Towing / transportation / storage**

## Recovering vehicles involved in accidents

When loading, transporting and storing, the instructions in the rescue cards must be observed.

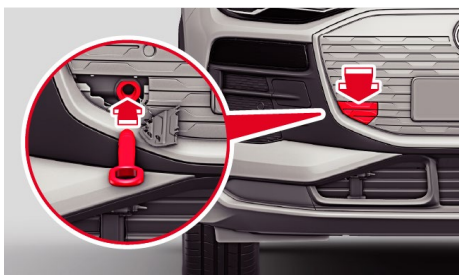

Example illustration (front towing eye)

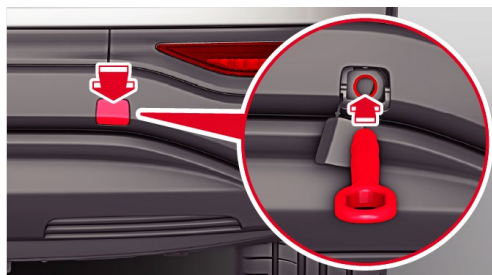

Example illustration (rear towing eye)

**The rescue and emergency services on site decide on the respective procedure.**



### Recovering high-voltage vehicles involved in accidents from a danger area

Vehicles with high-voltage batteries should, in principle, be transported away on flatbed vehicles.

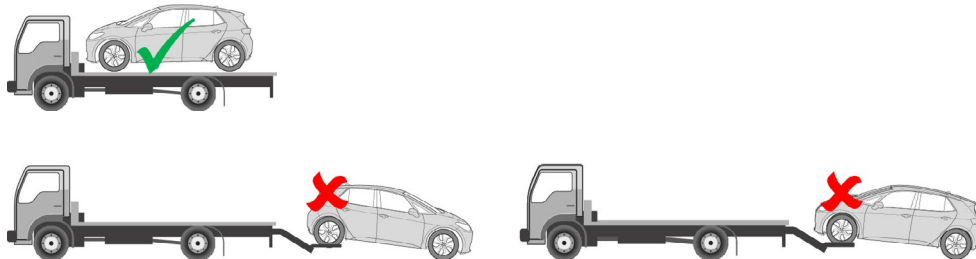

Before transport, the high-voltage system must be deactivated, see chapter 3. [Disable direct hazards / safety regulations](#).

Before transporting the vehicle (e.g. by a towing company), the condition of the lithium-ion battery should be checked again. The vehicle may only be loaded and transported away if the vehicle does not show any signs of a reaction near the lithium-ion battery for an extended period, see the flow chart on the next page.

If vehicles that have been in accidents have a damaged battery or the battery exhibits anomalies, wait until the reaction of the lithium-ion battery has abated before loading, so that no further reaction need be expected on the transport route, see the flow chart on the next page. The shortest and safest route possible must be selected. Travelling through tunnels should be avoided. If there is any need or doubt, it may be necessary to have the breakdown truck accompanied by a fire engine.

Vehicles with a damaged high-voltage battery should be transported to a safe storage location.

After transport, electric or hybrid vehicles that have been in accidents should not be parked in enclosed buildings, but outdoors at a sufficient distance from other vehicles, buildings and combustible objects or surfaces.

If possible, use designated “quarantine areas” at the storage location. The vehicle that was involved in the accident must be parked outdoors in a suitable location due to the potential which exists, in theory, for the lithium-ion battery to still react. The parking space must be marked accordingly (signs/fencing).

A minimum distance of five metres must be maintained to other vehicles, buildings or flammable objects. The distance can be reduced by taking appropriate measures, e.g. fire barriers etc.

The persons responsible at the towing company, the workshops and, if relevant, the scrapyard must be made aware of the special features of and risks presented by the vehicle.



**Lithium-ion batteries can self-ignite or re-ignite after fire-fighting measures!**



**In the event that vehicles that have been in accidents have a damaged high-voltage battery or the battery exhibits anomalies: deactivate the high voltage system (see chapter 3. [Disable direct hazards / safety regulations](#)). Park the vehicle at a safe distance of at least 5 metres from buildings and other vehicles (quarantine area)!**



**When loading the vehicle, take care not to damage the high-voltage components. If possible, lift the vehicle at the indicated lifting points.**



## 8. Towing / transportation / storage



Vibrations during transport may cause high-voltage batteries to self-ignite again.

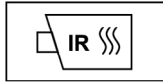

Whenever possible, monitor any changes in temperature using corresponding devices, e.g. IR camera, for an extended period.

Recommendations for specific vehicles can be found on their rescue cards.

A large metal container is recommended for transporting a high-voltage energy storage unit or parts thereof that have been disconnected from the vehicle.

The condition of the high-voltage energy storage unit must be observed (e.g. development of smoke, noises, sparks, development of heat) and flooding of the metal container must be prepared.

Further information on this subject can be found in chapter 5. Stored energy / liquids / gases / solids (Important information on this can be found in chapter 6. In case of fire. Information on how to handle the energy stored in the battery can also be found in chapter 8. Towing / transportation / storage.).

Before transporting the vehicle, the condition of the lithium-ion battery must be checked.

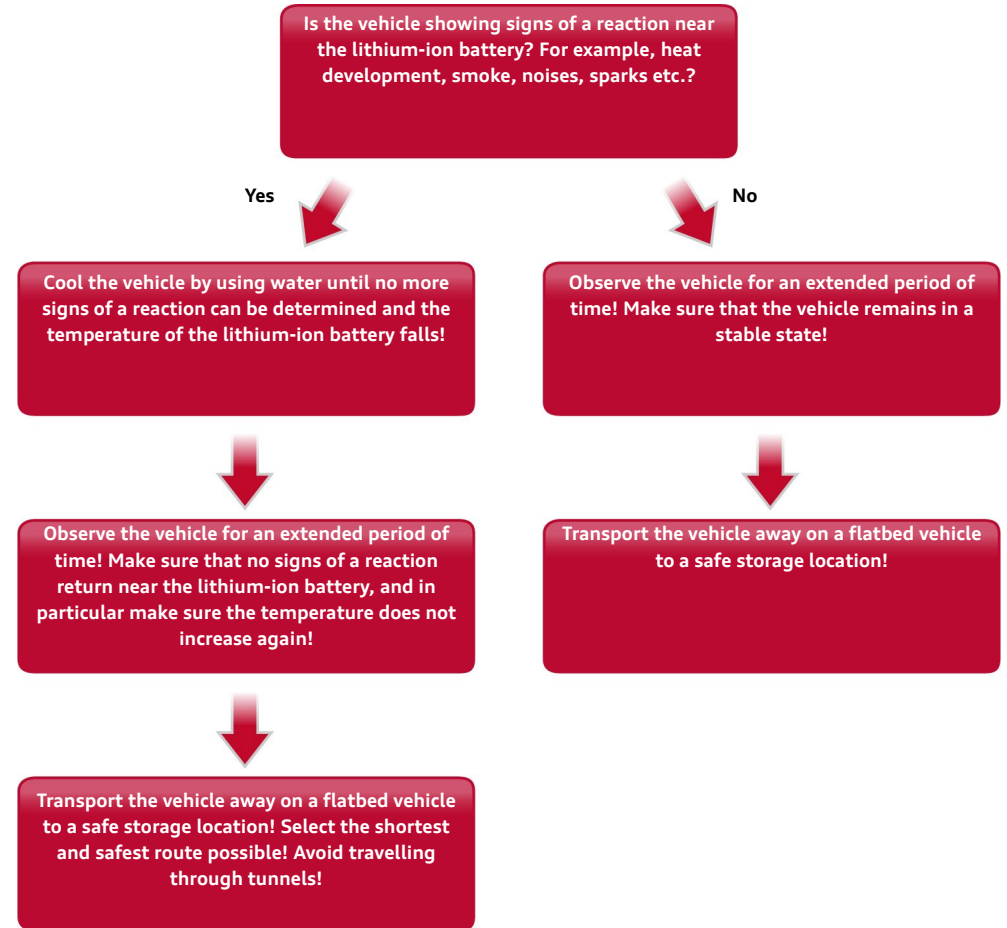

Flow chart for towing electric vehicles.



## Recovering natural gas vehicles involved in accidents from a danger area

When loading, transporting and storing, the instructions in the rescue cards must be observed.

The natural gas tanks must be manually shut off before transport, see chapter 3. Disable direct hazards / safety regulations.



**Do not use the drive axles to tow away a vehicle that was in an accident!**



**When towing and parking the vehicle, make sure that the gas tanks are not damaged!**



**If gas escapes, manually shut off the tank shut-off valves (see chapter 3. Disable direct hazards / safety regulations)!**

**Recommendations for specific vehicles can be found on their rescue cards.**

# 9. Important additional information

Modern vehicles have extensive occupant protection systems which can vary according to the vehicle type and specification package.

### Airbag

A current vehicle with maximum equipment includes the following main components:

- Airbags
- Airbag control unit
- Sensors
- Belt tensioners
- Components that release the rollover bar in convertibles

Preloaded springs or pyrotechnics are used to trigger it. The job of the electronics integrated in the airbag control unit is to detect vehicle deceleration and acceleration and decide whether to deploy protection systems. In addition to the sensors in the airbag control unit, additional sensors (e.g. crash sensors in the front doors) are also used to detect vehicle deceleration and acceleration during an accident. Only once they have evaluated the information from all sensors do the electronics in the airbag control unit decide whether and when to activate the safety components. Depending on the nature and severity of the accident, they may only deploy the belt tensioners or the tensioners together with the airbags, for example. The control unit is indicated as follows on the rescue cards:



**Airbag control unit**

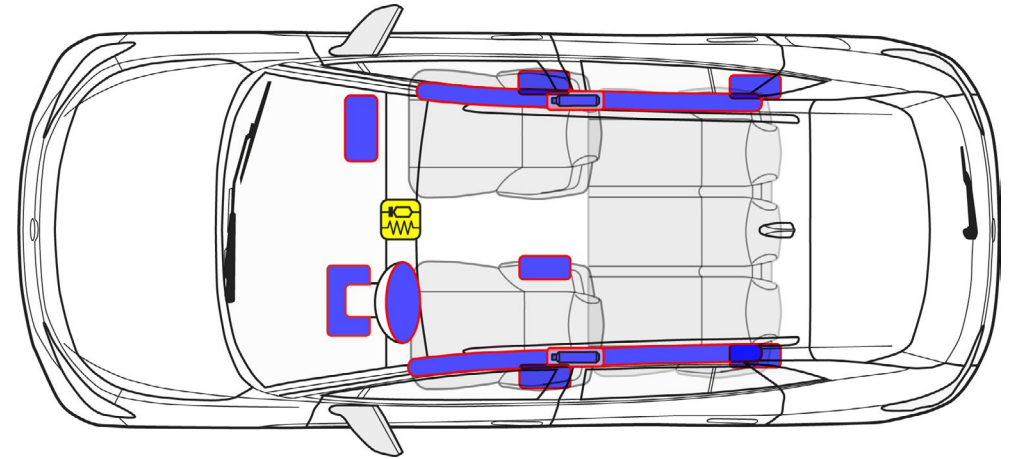

**Airbags in modern vehicle models.**

Only those safety systems which afford protection in the specific accident situation are triggered.

In addition to the main function for controlling the airbags, the airbag control unit may have the following additional functions:

- Emergency release of the central locking
- Switching on the interior lights
- Switching off the fuel pump
- Switching on the hazard warning lights
- Transmission of a signal to send the eCall

Gas generators produce the quantity of gas required for inflating the airbags, filling the airbags within milliseconds. The inflated airbags protect vehicle occupants who are wearing seatbelts from striking the inner body contours (e.g. the steering wheel, dash panel etc.) in the event of a severe accident. Depending on the installation location and requirements, stored gas inflators of various designs or modes of action are used.

# 9. Important additional information

The safety systems are triggered depending on the type of accident or direction of impact

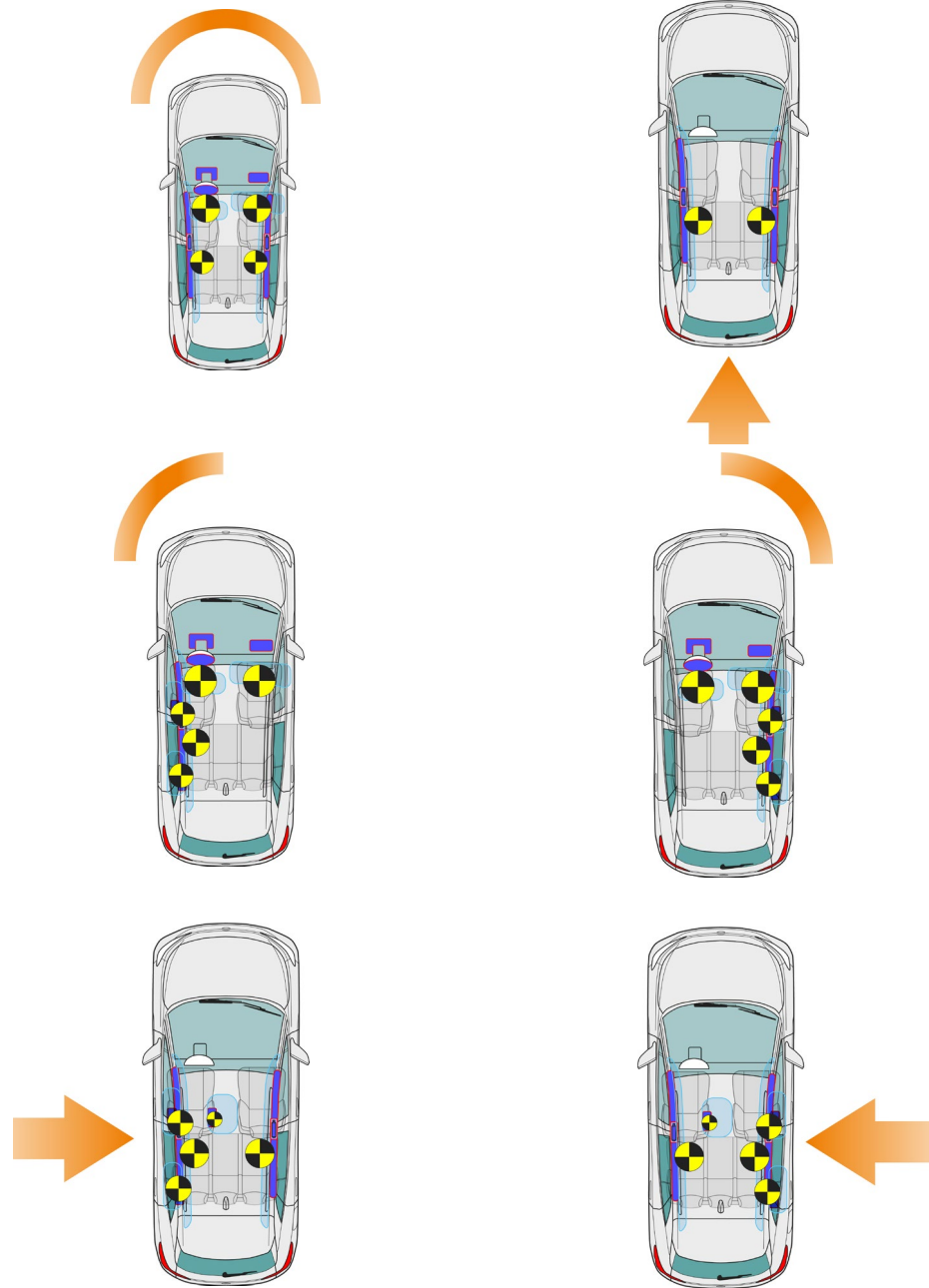

The safety systems are triggered depending on the type of accident or direction of impact (ms = milliseconds).

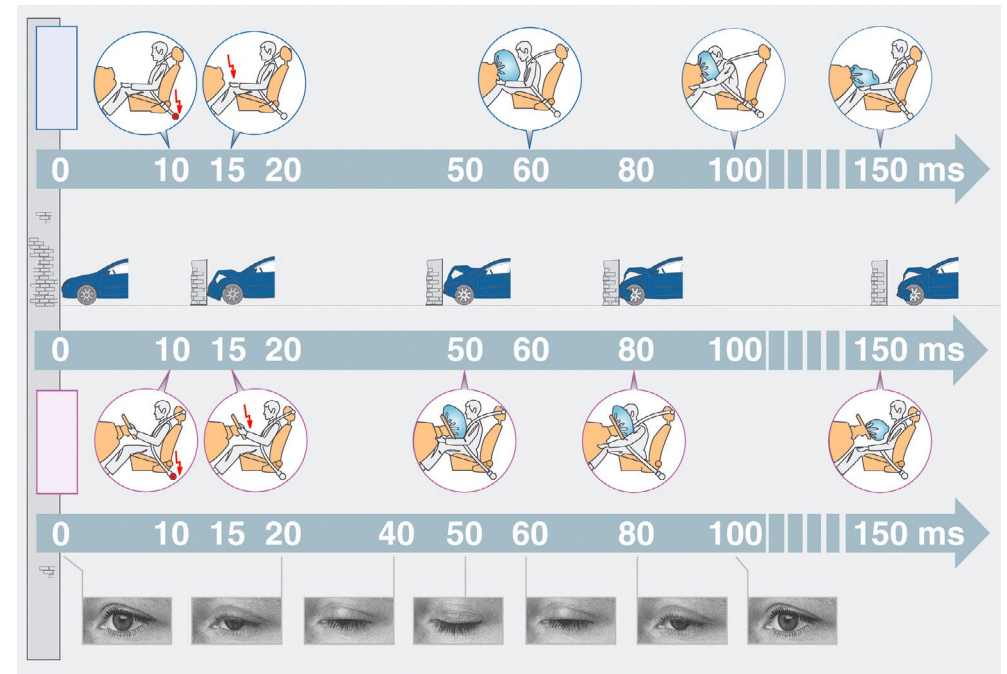

Airbags are indicated in the rescue cards as symbols or outlines as follows:



**Driver airbag, front passenger airbag, side or centre airbag, knee airbag and curtain airbag**

### Front airbags

#### Driver airbag

The driver airbag unit essentially consists of a cap, the airbag and a stored gas inflator. It is fitted in the steering wheel and electrically connected to the airbag control unit via a contact unit.

The airbag is folded up under the cap and its shape and size are designed so that it inflates as protection between the driver and steering wheel.

The driver airbag is inflated by a stored gas inflator. The unfolding airbag breaks the cap on the steering wheel along a special seam and is instantly filled with gas. The entire process from ignition of the stored gas inflator to the fully inflated airbag only takes a few milliseconds.

Vents on the side facing away from the driver reduce the kinetic energy of the upper body impact by allowing the gas to escape at a controlled rate.

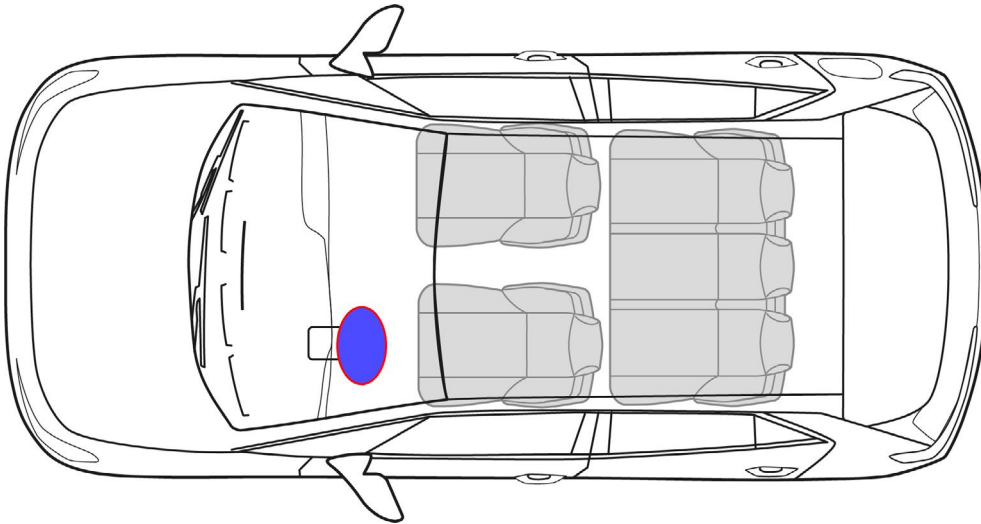

#### Front passenger airbag

The airbag unit for the front passenger is located in the dash panel in front of the passenger seat. Because the airbag unit is further from the occupant, the front passenger airbag has a much larger volume. The action, function and process sequence of the front passenger airbag are comparable to those of the driver airbag.

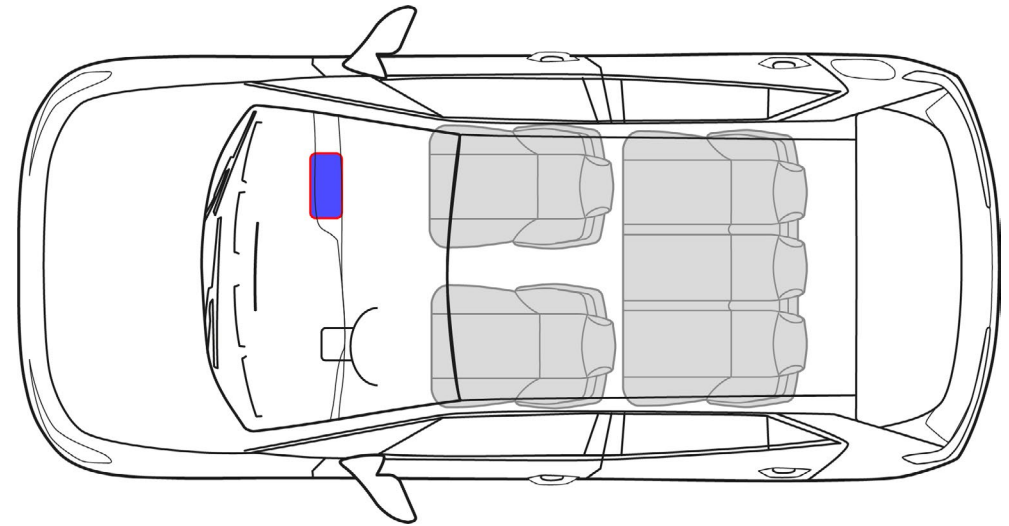

## 9. Important additional information

### Knee airbag

The design of the knee airbag is similar to that of the front passenger airbag. It is located in the footwell trim below the dash panel.

The knee airbag is always deployed together with the driver airbag. Single-stage stored gas inflators are used to inflate the knee airbags.

The deployment of the knee airbag reduces the occupants' risk of knee and leg injury, and connects the occupant sooner to the vehicle's deceleration.

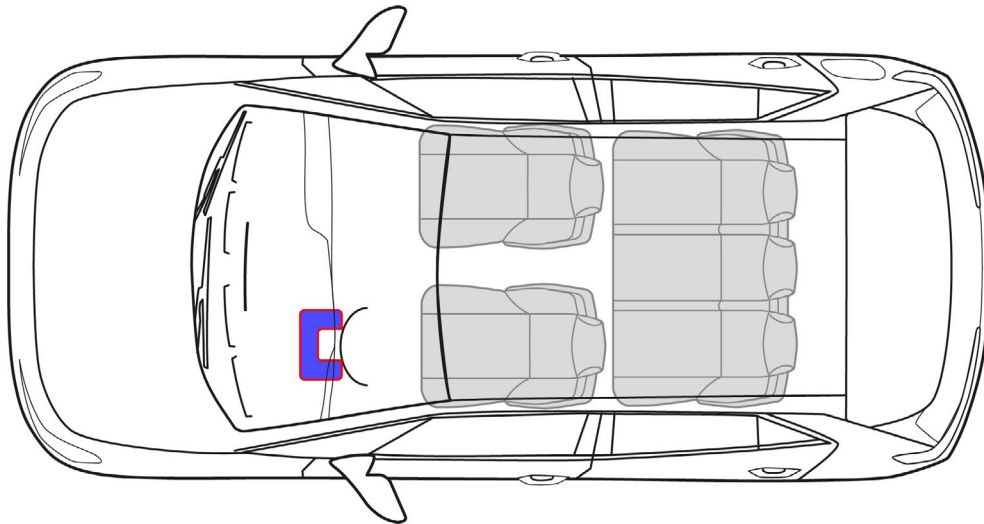

### Side airbag

In a lateral collision, side airbags protect the occupant's thorax and pelvis on that side of the vehicle and reduce the impact on the occupant. They inflate at the side between the occupant's upper body and any trims that protrude, and therefore distribute the force of the impact on the occupant more evenly, who is thereby paired with the motion of the intrusion early on.

The side airbags are installed in the backrest of the driver and front passenger seats, and on the outer seats in the 2nd row of seats in a number of Audi models. This guarantees a uniform distance to the vehicle occupants in every seat position.

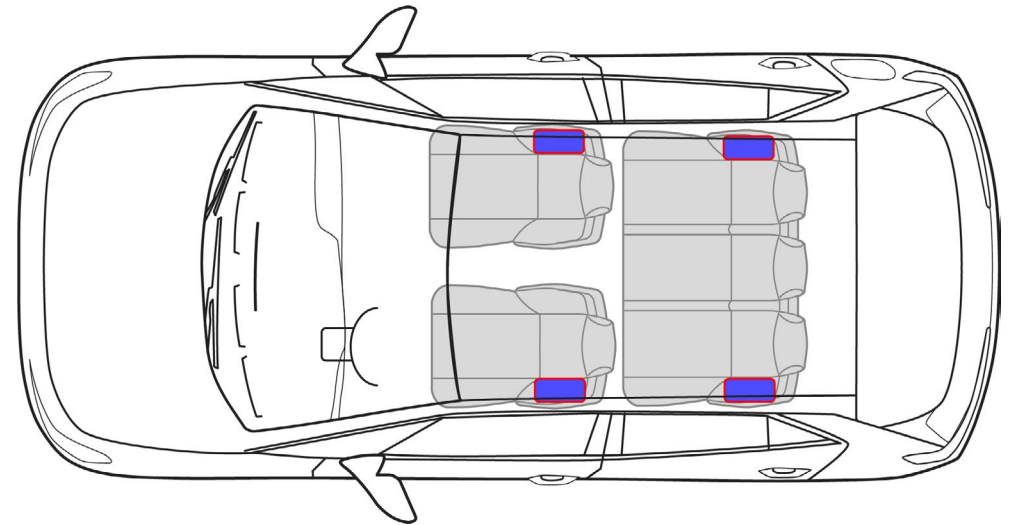

### Head/thorax airbags

The head-thorax airbags for the driver and front passenger are integrated in the front seat backrests. The design and function are similar to those of a side airbag.

It extends from the occupant's ribcage to the head and is particularly used in convertibles where a curtain airbag is not possible.

## 9. Important additional information

### Centre airbag

Centre airbags are installed in the driver seat armrest on the tunnel side. They prevent a collision between the heads of the driver and the front passenger, and prevent the driver from being thrown too far to the passenger side if it is unoccupied.

In the four-seater variant of the Audi A8 L, an additional rear centre airbag is installed in the rear shelf.

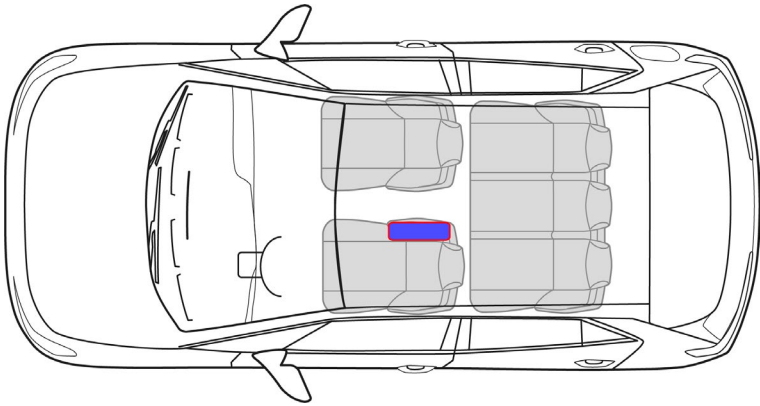

Centre airbag, front, tunnel side

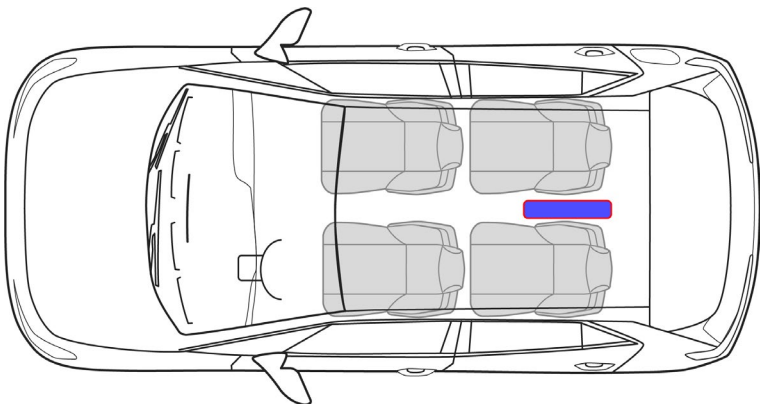

Rear centre airbag in the Audi A8 L four-seater

### Curtain airbags

Curtain airbags are designed to protect the head in the event of a side impact. They consist of a large airbag up in the roof lining which usually extends from the A-pillar to the C-pillar.

Depending on the vehicle model, the stored gas inflators may be installed in the roof near the B-pillar, between the B- and C-pillars, between the C- and D-pillars or even in the rear roof area. The exact installation position is described on the rescue cards.

In contrast to front and side airbags, the curtain airbag can retain its internal pressure for some time after being deployed. This is to provide protection if the vehicle subsequently overturns or secondary collisions occur.

Both the side and curtain airbags are deployed by the airbag control unit when a limit configured in it is reached. A side impact is detected by lateral acceleration sensors or pressure sensors in the doors.

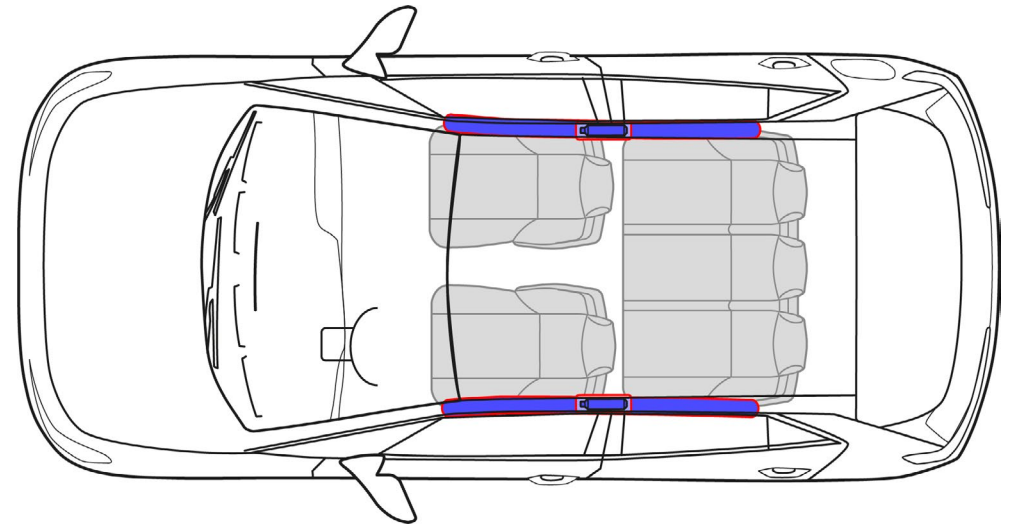



## Airbag stored gas inflators

### Solid propellant generators

The solid propellant stored gas inflators consist of a housing containing a solid propellant charge with an ignition unit. When the solid propellant is ignited, the airbag is filled with non-toxic gas.

#### Procedure:

- The igniter is activated by the airbag control unit.
- The propellant charge is ignited and quickly combusts.
- The gas thus produced flows through the metal filter into the airbag.

### Hybrid stored gas inflators

The hybrid stored gas inflators consist of a housing containing a highly compressed gas, combined with a solid propellant charge and an ignition unit. The design and shape of the generator housing are adapted to the installation conditions. These generators are usually tubular. The main components are the pressure vessel for the airbag inflation gas, and the (solid) propellant charge which is integrated in the pressure vessel or flange-mounted on it. The solid propellant is used in tablet or ring form. The stored and compressed gas is a mixture of inert gases, for example argon and helium. Depending on the stored gas inflator design, it is pressurised to between 200 bar and 800 bar.

- When the solid propellant is ignited, it opens the pressure vessel, producing a gas mixture consisting of the solid propellant and the inert gas mixture. The igniter is activated by the airbag control unit and the propellant charge is ignited.



**Do not damage the stored gas inflators during rescue work! The compressed gas in the pressure vessel and the pyrotechnic propellants may pose a hazard to the emergency services and the occupants.**

## Belt tensioners

In the event of a crash, belt tensioners retract the belt in the opposite direction to which it is being pulled – this reduces slack (a gap between the belt and the body). This acts as soon as possible to prevent the occupant from being thrown forward (relative to the motion of the vehicle). A belt tensioner can retract the seat belt by up to 200 mm within 10 ms. The belt tensioners are integrated in the belt system. However, they may be installed in different locations depending on the type of vehicle (for example in the B-pillar, in the side member beside the seat or on the outside of the rear seat) and have different functional principles. In some cases, two belt tensioners may even be used on one seat.



**This means belt tensioners should not be damaged with rescue equipment if at all possible. Avoid hammering on this area.**



**The belt also locks if the vehicle is at a steep angle, has overturned, or possibly if the belt tensioner has been damaged by the accident.**



**Non-triggered belt tensioners with mechanical activation can still be triggered even after the battery is disconnected.**

**If the situation allows, the seat belt should be taken off or cut off as soon as possible.**



**Belt tensioner**

Installation variants

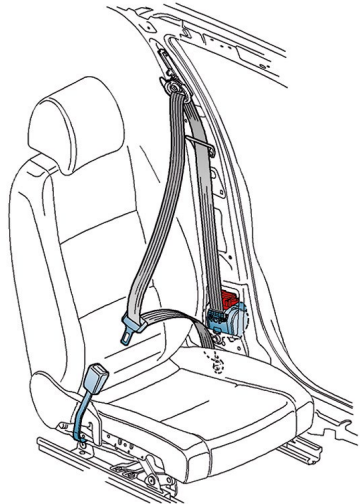
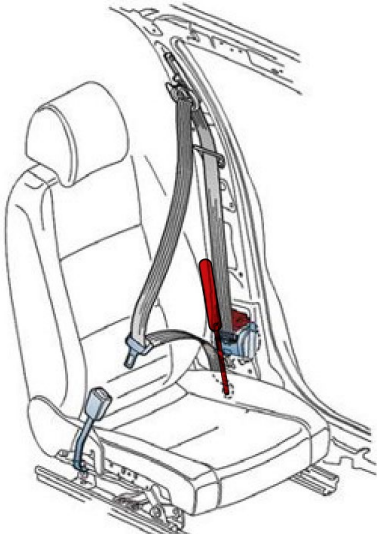
Variant	Installation location
	<p><b>Driver/front passenger, variant 1</b>                      In the case of the front compact tensioner, the three-point automatic seat belt and belt tensioner with electric or mechanical ignition trigger form a single unit and are installed in the B-pillar.</p> <p><b>Driver/front passenger, installation variant 1 - Compact tensioner in the B-pillar</b></p>
	<p><b>Driver/front passenger, variant 2</b>                      Compact tensioner (three-point seat belt with belt tensioner) and lap belt tensioner are both installed in the B-pillar (both tensioners with electrical triggering of the ignition).                      The lap belt tensioner is installed above the compact tensioner.</p> <p><b>Driver/front passenger, installation variant 2 - Compact tensioner and lap belt tensioner in the B-pillar</b></p>

Installation variants

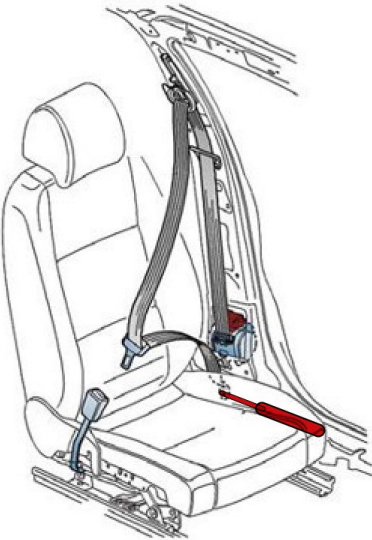
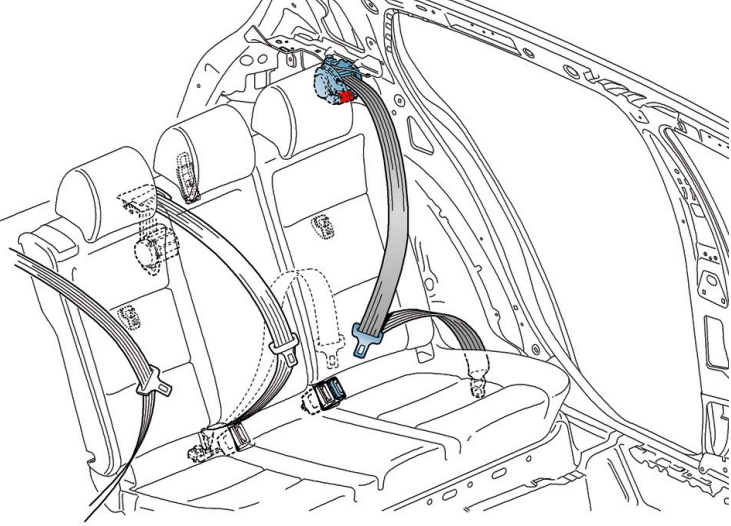
Variant	Installation location
	<p><b>Driver/front passenger, variant 3</b>                      Compact tensioner (three-point seat belt with belt tensioner) and lap belt tensioner are installed independently of each other (both tensioners with electrical triggering of the ignition).                      The lap belt tensioner with electric triggering of the ignition is installed on the side member/B-pillar.</p> <p><b>Driver/front passenger, installation variant 3 – Compact tensioner in the B-pillar, lap belt tensioner in the area of the side member/B-pillar</b></p>
	<p><b>Rear seat variant 1</b>                      In the rear compact tensioner, the three-point seat belt and belt tensioner with electric or mechanical triggering of the ignition form a single unit and are installed behind the rear seat backrest.</p> <p><b>Rear seat, installation variant 1 – Compact belt tensioner in the rear in the area of the C/D pillar (in vehicles with belt tensioner for the centre rear seat, the compact belt tensioner is located in the backrest)</b></p>

Installation variants

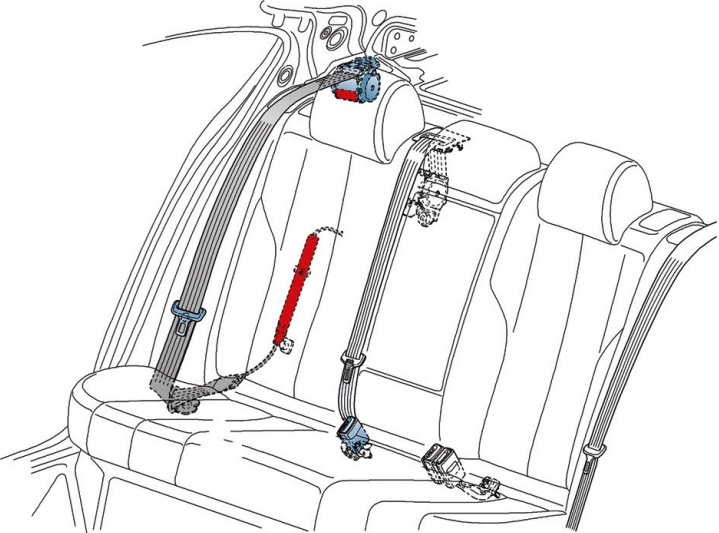
Variant	Installation location
	<p><b>Rear seat variant 2</b>                      The rear compact tensioner (three-point seat belt with belt tensioner) and the lap belt tensioner are arranged independently of each other. The compact tensioner with electrical triggering of the ignition is installed in the C/D-pillar area. The lap belt tensioner with electrical triggering of the ignition is installed in the wheel housing / C-pillar area.</p> <p><b>Installation variant 3 – Compact tensioner and lap belt tensioner in the C/D-pillar area or C-pillar/wheel housing area</b></p>

## Protective bar

Convertibles must provide the greatest possible protection for occupants even when the roof is open. This is why a rollover protection system is used, which provides a protective zone for the occupants in combination with reinforced A-pillars. It can be rigid or dynamic.

A dynamic system functions as follows:

- The airbag control unit contains a sensor for detecting if the vehicle is about to roll over.

Together with other sensors in the control unit, the severity of the accident is determined and the protective bar and belt tensioners are deployed. The protective bar is also deployed as a precaution in the event of a severe frontal, lateral or rear impact as soon as a belt tensioner or airbag is triggered. It is deployed via a protective bar trigger unit. A preloaded spring moves the bar to the protective position within 0.25 seconds, and it is locked in the extended position by a latching mechanism.



If the rear window is still intact when the protective bar is triggered, the protective bar may not always break it. If the window is removed as part of the rescue operation, the protective bar is pushed up a further 10 cm. It could hit emergency and recovery personnel and scatter glass shards.



Automatic protective bar system

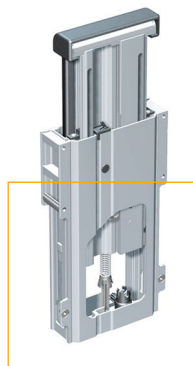

Protective bar not triggered

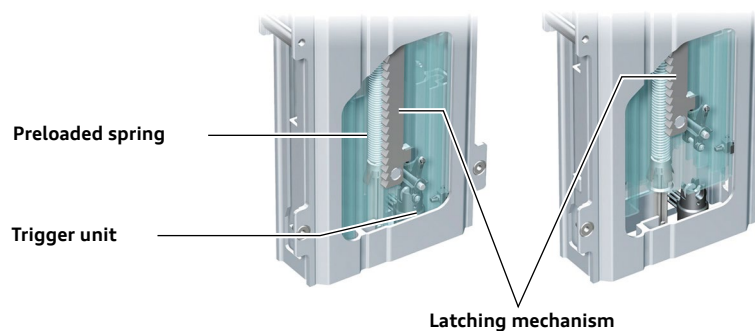

Protective bar triggered

Example of a dynamic protective bar

### Re-active bonnet

To ensure optimum protection for pedestrians, some Audi vehicles are equipped with a re-active bonnet.

In the event of a collision with a pedestrian, the front and rear of the active bonnet are raised by preloaded gas struts and pyrotechnic propellants. This increases the space between the bonnet and engine. The bonnet can absorb more impact energy in this position, thereby reducing the severity of injury caused by the engine.

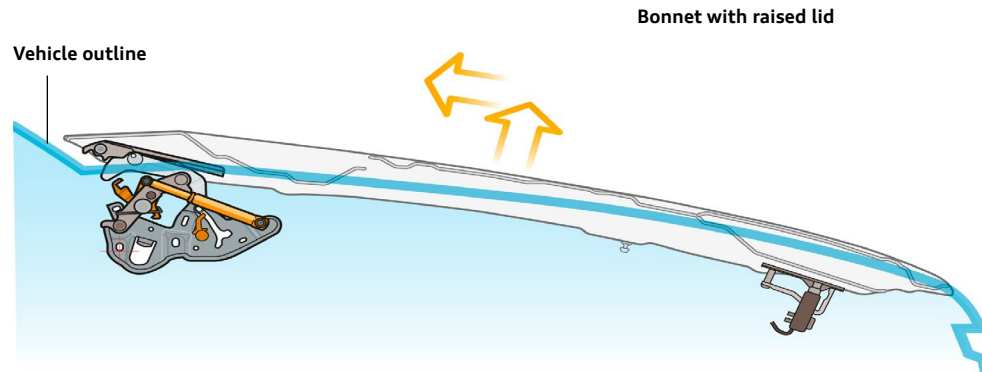

**Do not damage the stored gas inflators during rescue work. The compressed gas in the pressure vessel and the pyrotechnic propellants may pose a hazard to the emergency services and the occupants.**



**Pedestrian protection active system**

### Sources, further information

- VDA: Accident assistance and recovery of vehicles with 48 V and high-voltage systems
- DGUV: Hinweise für die Brandbekämpfung von Lithium-Ionen-Akkus bei Fahrzeugbränden (Information for fighting fires in lithium-ion batteries in vehicle fires) (FBFHB 024)
- [www.audi.com/de/rescue.html](http://www.audi.com/de/rescue.html)

# 10. Explanation of pictograms used

## 10. Explanation of pictograms used

Components, functions and measures that have to be taken into account during a rescue operation are indicated by special pictograms.





The uniform pictograms have the following objectives:

- to indicate on the rescue card where the respective components/functions are located in the vehicle  
(for details, see ISO 17840-1 and ISO 17840-2)
- to indicate a specific function or danger; they can be used in the sections of the additional pages of the rescue card or the guide for emergency personnel
- to show how to identify the type of drive,
- to outline fire-fighting measures.

**A number of pictograms may be adapted to reflect the actual size and shape.**

**A combination of simple forms can also be used.**

### Pictograms for recognising the type of drive

	Vehicle on fuel of liquid group 1; diesel
	Vehicle on fuel of liquid group 2; petrol
	Hybrid Electric Vehicle on fuel of liquid group 2; petrol/ electric
	Electric vehicle
	Vehicle with petrol-CNG drive



## 10. Explanation of pictograms used

### Pictograms for access to components

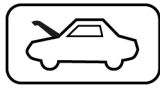

Bonnet

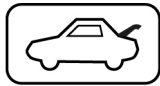

Boot

### Pictograms concerning disabling of the vehicle (excluding high voltage)



Device to shut down power in the vehicle



Remove smart key

### Pictograms concerning disabling of the vehicle's high-voltage system (EV, HEV, PHEV, FCEV)



Dangerous voltage

### Pictograms concerning disabling of the vehicle's high-voltage system (EV, HEV, PHEV, FCEV)

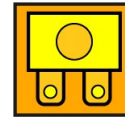

Fuse box disabling high voltage



Cable cut



High voltage device that disconnects high voltage



Low voltage device that disconnects high voltage

### Pictograms for access to occupants

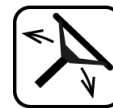

Steering wheel, tilt control



















Seat height adjustment



Seat adjustment, longitudinal





10. Explanation of pictograms used

Other vehicle-related pictograms	
	Airbag
	Stored gas inflator
	Belt tensioner
	Gas strut / preloaded spring
	Pedestrian protection active system
	Body reinforcement
	Zone requiring special attention
	Carbon structure



Other vehicle-related pictograms	
	Battery low voltage
	SRS control unit
	Battery pack, high-voltage
	High voltage component
	High voltage power cable
	Fuel tank, diesel
	Fuel tank petrol/ethanol
	Gas tank with gas type indication (CNG)

## 10. Explanation of pictograms used



### Other vehicle-related pictograms

	Manual gas shut-off valve with gas type indication (CNG)
	Gas line (generic)
	Air tank
	Air conditioning system

### Pictograms for firefighting and safety

	General warning sign
	Warning, Electricity
	Use thermal Infrared camera

### Pictograms for firefighting and safety

	Use water to extinguish the fire
	Use ABC powder to extinguish the fire

### World-wide standard symbols

	Explosive
	Flammable
	Gases under pressure
	Corrosive/skin irritant
	Danger to health

---

**World-wide standard symbols**



Environmental hazard